

GENERAL CATALOG



TORQUE WRENCH

AND ANALYZER

<http://www.bestool-kanon.co.jp>



NAKAMURA MFG.CO.,LTD.
TSURU FACTORY



ISO 9001
JQA-2434



ISO 14001
JQA-EM1367

BESTOOL-KANON

Exploring the frontiers of higher accuracy and reliability.

Every single fastener fulfills an important function maintaining the life of every product.

In the transportation or chemical industries, if a fastener loosens from improper tightening, it might cause a serious disaster costing human life.

We focus our techniques and wisdom, accumulated over many years, on preventing such occurrences.

Tightening only by hand will cause unexpected disaster.

For example,

Traffic accidents

Improper wheel nut tightening resulting in wheels coming off.

Construction accidents

Improper tightening of structural joints resulting in collapsing scaffolding or buildings.

Explosions

Improperly tightened underground gas line joints resulting in leakage and explosion.

Chemical accidents

In chemical plants, improperly tightened joints can release toxic substances.

Torque tools play an important role in preventing such incidents.

Torque tools tighten joints uniformly with adequate force.

In particular they serve:

1. To prevent under-or-over-tightening.
2. To tighten multiple bolts uniformly.
3. To adequately generate the clamping force required for bolted joints.

BESTOOL-KANON

NOTE: Can be calibrated to : Inch pounds,
Foot pounds, Newton meters.

PAGE 3
SPK
PRE-SET
TORQUE WRENCHES



PAGE 4
RSPK
PRE-SET, RING
TORQUE WRENCHES



PAGE 5
QLK
ADJUSTABLE, RATCHET
TORQUE WRENCHES



PAGE 6
GLK/BLK
ADJUSTABLE, RATCHET TORQUE
WRENCHES WITH PLASTIC GRIP



PAGE 7
QSPK
QSPKH, QSPK-A



PAGE 8
SPCK/SPCKH
PRE-SET, REPLACEABLE HEAD
TORQUE WRENCHES



PAGE 9
LCK/GCK
ADJUSTABLE, REPLACEABLE
HEAD TORQUE WRENCHES



PAGE 10
HEADS
OPTIONAL REPLACEABLE
HEADS



PAGE 11
**QLK-LR/
HYK**



PAGE 12
DLT-N
KANON DIGITAL TORQUE
WRENCH



PAGE 13
FK
INDICATOR PLATE
TORQUE WRENCHES



PAGE 14
TOK-G
DIAL INDICATOR
TORQUE WRENCHES

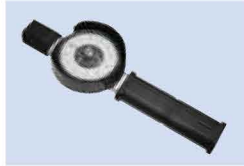

PAGE 15
LTDK
CLUTCH RELEASE TORQUE
SCREW DRIVERS



PAGE 16
STDK
PRE-SET TORQUE DRIVERS



PAGE 17
DPSK
DIAL GAUGE
TORQUE DRIVERS



PAGE 18
SGK
TORQUE GAUGES



PAGE 19
KDTA-SV
DIGITAL TORQUE ANALYZERS



PAGE 20
KDTA-SVH
LARGE DIGITAL TORQUE
ANALYZERS



PAGE 20
TPK-3
STANDARD PRINTER



PAGE 21
KDTA-SVII
DIGITAL TORQUE ANALYZERS



PAGE 21
CTK-XL CAP
TESTER
DIGITAL TORQUE ANALYZERS
FOR TORQUE DRIVERS



PAGE 22
KDTA-DH
DIGITAL TORQUE ANALYZERS
FOR TORQUE DRIVERS



PAGE 22
KDTA-D
DIGITAL TORQUE ANALYZERS
FOR ELECTRIC DRIVERS



PAGE 23
DRT
KANON TORQUE MEASUREMENT
MULTI-INDICATOR



PAGE 24
MLQK
MLQK-E



PAGE 25
TCSK-99MA
SWPM Series



PAGE 26
TK
TENSION GAUGES



PAGE 27
DTC-EXL
DATA PRINT-OUT DIGITAL
TORQUE WRENCHES



PAGE 28
DTDK-EXL
DIGITAL TORQUE DRIVER
WITH CONNECTED DISPLAY



PAGE 28
DTC-N5EXL
DIGITAL TORQUE WRENCH
WITH CONNECTED DISPLAY



SPK PRE-SET TORQUE WRENCHES

Audible and tangible "CLICK" when the set torque is reached, assuring a securely tightened joint. This series is well-suited for production line use.

FEATURES

- A single function wrench, used for a single setting combination of fastener size and torque setting.
- Most suited for tightening multiple same-size fasteners at the same torque in a production line.
- Setting confirmation unnecessary.
- Can be used effectively in confined spaces.
- Tightening to set torque only in the direction of the arrow indicator, but can be used for general tightening in the other direction as well.
- Accuracy : $\pm 3\%$ of pre-set value

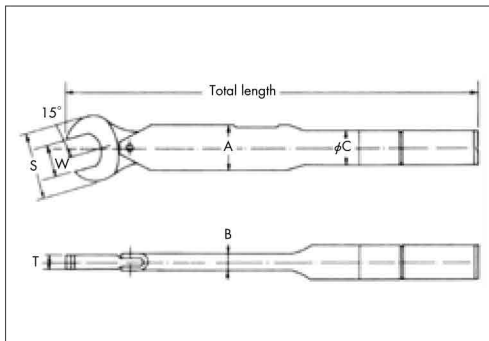

EXAMPLE OF ORDER

Model	Size(W)	Pre-set Value
N190SPK	10	× 14N·m

Model (kgf·cm)	Range (kgf·cm)	Old Model (N·m)	New Model (N·m)	Range (N·m)	Spanner sizes (W) mm	Total length mm	Dimensions (mm)					Weight kg
							Head		Body			
							S	T	A	B	C	
30SPK	5~30	N30SPK	N35PK	0.5~3	5.5 6 7 8 9 10	152	24	5	19.5	7.5	15	0.1
80SPK	15~80	N80SPK	N85PK	1.5~8	5.5 6 7 8 9 10 11 12 13	175	24	5	19.5	7.5	15	0.11
190SPK	35~190	N190SPK	N195PK	3.5~19	10 11 12 13 14 17 19	203 205 213	27 30 35	7	19.5	7.5	15	0.15
380SPK	80~380	N380SPK	N385PK	8~38	10 11 12 13 14 17 19 21 22 23 24 26 27 29 30 32	248 252 256 264 319 325 330 342 390 397 403 404 435 442 449 457	35 39 45 52 45 50 56 65 52 57 62 64 53 56 64 73	8 9 10	26.6	8.2	20	0.29
670SPK	130~670	N670SPK	N675PK	13~67	14 17 19 21 22 24 26 27 30 32 36 41	319 325 330 342 390 397 403 404 435 442 449 457	45 50 56 65 52 57 62 64 53 56 64 73	11	25.8	9.7	20	0.45 0.46 0.47 0.49
1200SPK	240~1,200	N1200SPK	N1205PK	24~120	17 19 22 24 26 27 29 30 32 36 41	390 397 403 404 435 442 449 457	52 57 62 64 53 56 64 73	12 14	32.8	11.3	25	0.75 0.77 0.79 0.81 0.94 0.97 0.99
1600SPK	300~1,600	N1600SPK	N1605PK	30~160	19 22 24 26 27 30 32 36 41	435 442 449 457	53 56 64 73	12 14	32.8	11.3	25	1.1 1.2 1.4 1.5
2200SPK	450~2,200	N2200SPK	N2205PK	45~220	24 27 30 32 36 41	585 597	72 82	15	35.6	12.5	27.2	1.1 1.2 1.4 1.5
3100SPK	650~3,100	N3100SPK	N3105PK	65~310	22 24 27 30 32 36 41	650 654 662	67 72 82	16	38.0	16	30	1.3 1.32 1.4
4200SPK	900~4,200	N4200SPK	N4205PK	90~420	24 27 30 32 36 41 46	833 838 843 847 860	74 78 88 88 94	18	43.3	17.8	34	1.45 1.46 1.47 1.5 1.52

* is the new model that is applied from 1st January, 2016.

RSPK PRE-SET, RING TORQUE WRENCHES

Can be used for accurate torque application even on joints inaccessible with other wrenches.

FEATURES

- The ring head of RSPK wrenches is offset at a 45° angle making certain joints particularly accessible.
- A single function wrench, used for a single setting combination of fastener size and torque setting.
- Most suited for tightening multiple same-size fasteners at the same torque on a production line.
- Setting confirmation unnecessary.
- Accuracy : ±3% of pre-set value

EXAMPLE OF ORDER

Model Size(W) Pre-set Value
 | | |
 N190RSPK 10 × 14N·m



Model	Ring head sizes (W)		Dimensions Head		Model	Ring head sizes (W)		Dimensions Head		Model	Ring head sizes (W)		Dimensions Head	
	mm	mm	S	T		mm	mm	S	T		mm	mm	S	T
30RSPK N30RSPK	5.5	6	4		80RSPK N80RSPK	5.5	6	4		190RSPK N190RSPK	10	16	7	
	6	8	5			6	8	5			11	18		
	7	9	6			7	10	6			12	19	8	
	8	13				8	13				13	20	8.5	
	9	14				9	14				14	22	9	
	10	16	7			10	16	7		17	26	10		
						11	18				19	29	10.5	
						12	19	8			22	33	12	

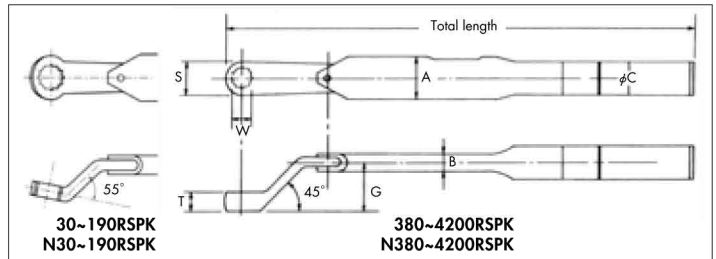

Model (kgf·cm)	Range kgf·cm	Old Model (N·m)	New Model (N·m)	Range N·m	Ring head sizes (W)					Total length mm	Dimensions (mm)						Weight kg
					mm						Head		Body				
					S	T	G	A	B		C						
30RSPK	5~35	N30RSPK	N3.5RSPK	0.5~3.5	5.5	6				175	★ 1		19.5	7.5	15	0.12	
					7	8	9	10									
					5.5	6	7										
80RSPK	20~90	N80RSPK	N9RSPK	2~9	8	9	10			197	★ 2		19.5	7.5	15	0.13	
					11	12											
					10												
190RSPK	40~210	N190RSPK	N21RSPK	4~21	11	12	13	14		222	★ 3		19.5	7.5	15	0.21	
					17	19	22	228									
					11	12	13	14									
380RSPK	90~420	N380RSPK	N42RSPK	9~42	11	12	13	14		268	22	10	25	26.6	8.2	20	0.31
					17	19	22	273									
					14	17		343									
670RSPK	140~730	N670RSPK	N73RSPK	14~73	19	22	24			348	34	12	27	25.8	9.7	20	0.46
					27	30	32	353									
					19			413									
1200RSPK	250~1,270	N1200RSPK	N127RSPK	25~127	22	24				415	37	13	29	32.8	11.3	25	0.85
					27	30	32	428									
					36			437									
1600RSPK	320~1,700	N1600RSPK	N170RSPK	32~170	19	22	24			470	37	15	31	32.8	11.3	25	1.0
					27	30	32	474									
					19			605									
2200RSPK	480~2,300	N2200RSPK	N230RSPK	48~230	22	24	27			608	41	16.5	33	35.6	12.5	27.2	1.25
					30	32		610									
					36			612									
3100RSPK	680~3,200	N3100RSPK	N320RSPK	68~320	22					682	40	18	35	38	16	30	1.35
					24	27	30	685									
					32	36		688									
4200RSPK	950~4,300	N4200RSPK	N430RSPK	95~430	27	30	32			880	52	18	37	43.3	17.8	34	1.45
					36			885									
					41			890									
					46					895	65						1.7

* is the new model that is applied from 1st January, 2016.

QLK ADJUSTABLE, RATCHET TORQUE WRENCHES

Freely set torque values within the capacity range. Replaceable socket, ratchet wrenches.

FEATURES

- The ratchet improves efficiency. These wrenches are well suited for repetitive work.
- By replacing the sockets, various sizes of fasteners can be tightened within the tool's capacity range.
- By reversing the ratchet, the wrench can be used to loosen fasteners counter-clockwise.
- Tightening to a torque setting can only be done clockwise.
- Accuracy : ±3% of indicated value over the full range.



ADJUSTING THE TORQUE SETTING

◆ 30QLK~5600QLK

- (1) Loosen the lock screw. (See Fig.1)
- (2) Turn the sub-scale and adjust to a torque value (the main scale plus the sub-scale)(See Fig.2)
- (3) Tighten the lock screw. (If the lock screw hits the pin before completely tightening, then change the position of the pin)

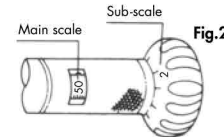
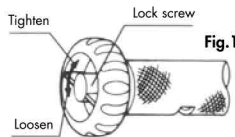

◆ 7000QLK~14000QLK

- (1) When applicable, mount the extension bar snugly all the way onto the body of the wrench.
- (2) With the extension bar mounted (See Fig.3), insert the hexagonal side of the adjusting box wrench.
- (3) Without the extension bar (See Fig.4), insert the hexagonal side of the adjusting box wrench into the body.

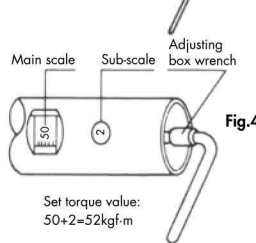
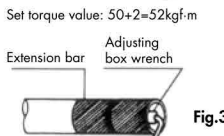

30~5600QLK

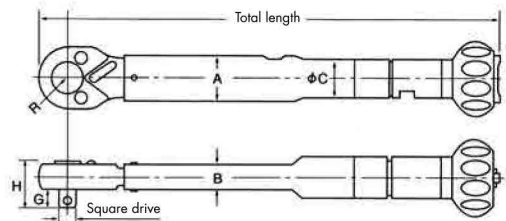

7000~21000QLK

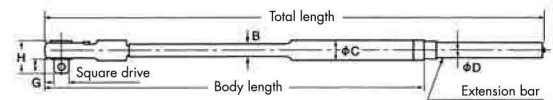

★ Torque adjusting box wrench

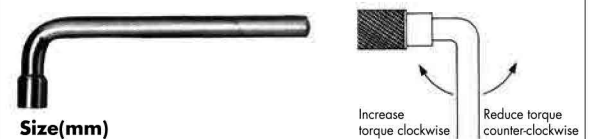

Size(mm)	
(N)7000QLK~10000QLK	8
(N)14000QLK~21000QLK	10

Model (kgf·cm/kgf·m)	Range	Increment	Old Model (cN·m/N·m)	New Model (cN·m/N·m)	Range	Increment	Model (lbf·in)	Range	Increment	Square drive	Total length	Dimensions (mm)							Weight kg	Standard Accessory
												Head		Body			Body length			
	kgf·cm/kgf·m	kgf·cm/kgf·m			cN·m/N·m	cN·m/N·m		lbf·in	lbf·in	mm	mm	H	G	R	A	B		C	D	
30QLK	10~30	0.5	N30QLK	CN300QLK	100~300	5				6.35 (1/4")	186	18.8	7.5	12					0.18	
60QLK	20~60	1	N60QLK	N6QLK	2~6	0.1													0.27	
120QLK	40~120	2	N120QLK	N12QLK	4~12	0.2	PI 120QLK	40~120	2						15.5	9.6	15		0.29	
230QLK	70~230	2	N230QLK		7~23	0.2	PI 230QLK	70~230	2											
250QLK	50~250	2	N250QLK	N25QLK	5~25	0.2				9.53 (3/8")	232	25	11	16	25	11.4	20		0.45	
450QLK	100~450	5	N450QLK		10~45	0.5	PI 450QLK	100~450	5											
500QLK	100~500	5	N500QLK	N50QLK	10~50	0.5														
900QLK	200~900	10	N900QLK	N90QLK	20~90	1														
1000QLK	200~1000	10	N1000QLK	N100QLK	20~100	1	PI 1000QLK	200~1000	10											
1400QLK	400~1400	10	N1400QLK	N140QLK	40~140	1				12.7 (1/2")	352	31	14	19.7	27.5	12.4	21.7		0.79	
1800QLK	400~1800	20	N1800QLK	N180QLK	40~180	2					392									
2000QLK	400~2000	20	N2000QLK	N200QLK	40~200	2	PI 2000QLK	400~2000	20		478	33		23	34				1.45	
2800QLK	4~28	0.2	N2800QLK	N280QLK	40~280	2										15.4	27.2		1.9	
3600QLK	8~36	0.2	N3600QLK	N360QLK	80~360	2					678	42		23.5	35				1.9	
4200QLK	6~42	0.2	N4200QLK	N420QLK	60~420	2				19.05 (3/4")	950	42.7	20	27	38	16	30		3.3	
5600QLK	8~56	0.3	N5600QLK	N560QLK	80~560	3					1,195	49.5		34	43.5	18	34		5	
7000QLK	10~70	0.5	N7000QLK	N700QLK	100~700	5					1,314			46	19.2	35.4	27.2	990	6.2	
8500QLK	10~85	0.5	N8500QLK	N850QLK	100~850	5					1,388								8.5	
10000QLK	10~100	0.5	N10000QLK	N1000QLK-8	100~1000	5					1,538	58		38	54	23	42.7	31.8	1,105	
14000QLK	20~140	1	N14000QLK		200~1400	10				25.4 (1")	1,844	61	27	44	66	26	51	40	1,144	
15000QLK	20~150	1	N15000QLK	N1500QLK	200~1500	10					2,064							34	1,704	
21000QLK	70~210	1	N21000QLK	N2100QLK	700~2100	10													19.5	

* is the new model that is applied from 1st January, 2016.

GLK ADJUSTABLE, RATCHET TORQUE WRENCHES WITH PLASTIC GRIP

Freely set torque values within the capacity range. Replaceable socket, ratchet wrenches.

FEATURES

- The ratchet improves efficiency. These wrenches are well suited for repetitive work.
- By replacing the sockets, various sizes of fasteners can be tightened within the tool's capacity range.
- By reversing the ratchet, the wrench can be used to loosen fasteners counter-clockwise.
- Tightening to a torque setting can only be done clockwise.
- Accuracy : $\pm 3\%$ of indicated value over the full range.



60~1400GLK

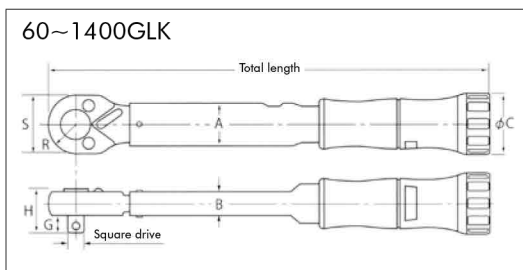

Model (kgf·cm)	Range	Increment	Model (N·m)	Range	Increment	Square drive	Total length	Dimensions (mm)							Weight
								Head				Body			
	kgf·cm	kgf·cm		N·m	N·m	mm	mm	H	G	S	R	A	B	φC	kg
60GLK	20~60	1	N6GLK	2~6	0.1	6.35	187	18.8	7.5	24	12	18.2	9.6	29	0.2
120GLK	40~120	2	N12GLK	4~12	0.2	(1/4")	233	25	11	31	15.5	32	16	25	0.28
250GLK	50~250	2	N25GLK	5~25	0.2	9.53 (3/8")	255	31	14	39.4	19.7	27.5	12.4	35	0.47
500GLK	100~500	5	N50GLK	10~50	0.5	12.7	355	31	14	39.4	19.7	27.5	12.4	38	0.8
1000GLK	200~1000	10	N100GLK	20~100	1	12.7 (1/2")	395	31	14	39.4	19.7	27.5	12.4	38	0.87
1400GLK	400~1400	10	N140GLK	40~140	1	12.7 (1/2")	395	31	14	39.4	19.7	27.5	12.4	38	0.87

BLK ADJUSTABLE BY HEX WRENCH, RATCHET TORQUE WRENCHES WITH PLASTIC GRIP

Freely set torque values within the capacity range. Replaceable socket, ratchet wrenches.

FEATURES

- Adjusted setting torque value by hex wrench.
- The ratchet improves efficiency. These wrenches are well suited for repetitive work.
- By replacing the sockets, various sizes of fasteners can be tightened within the tool's capacity range.
- By reversing the ratchet, the wrench can be used to loosen fasteners counter-clockwise.
- Tightening to a torque setting can only be done clockwise.
- Accuracy : $\pm 3\%$ of indicated value over the full range.



250~1000BLK

*Hex wrench is not included

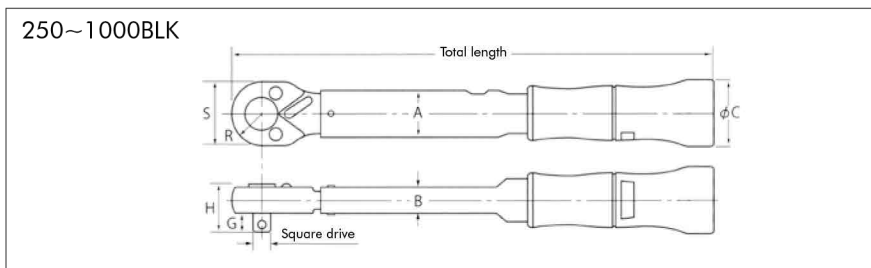

Model (kgf·cm)	Range	Increment	Model (N·m)	Range	Increment	Square drive	Total length	Dimensions (mm)							Weight
								Head				Body			
	kgf·cm	kgf·cm		N·m	N·m	mm	mm	H	G	R	A	B	C	kg	
250BLK	50~250	2	N25BLK	5~25	0.2	9.53 (3/8")	245	25	11	15.5	18.2	9.6	30	0.27	
500BLK	100~500	5	N50BLK	10~50	0.5	12.7	325	25	11	16	25	11.4	33	0.43	
1000BLK	200~1000	10	N100BLK	20~100	1	12.7 (1/2")	392	31	14	19.7	27.5	12.4	36	0.72	

QSPK PRE-SET, RATCHET TORQUE WRENCHES, METAL HANDLE

Pre-set torque value. Improved work efficiency with ratchet square drive.

FEATURES

- The ratchet drive enables quickly tightening fasteners to the preset torque. Suitable for repetitive jobs.
- The wrench's inner mechanism automatically resets itself for the the next job after disengaging from a tightened joint.
- Accuracy : ±3% of set value.

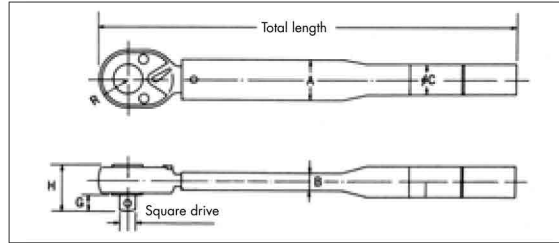

EXAMPLE OF ORDER

Model Pre-set Value
 | |
 N900QSPK × 72N·m



QSPK (Metal Handle)

Model (kgf·cm)	Range kgf·cm	Old Model (N·m)	New Model (N·m)	Range N·m	Model (lbf·in/lbf·ft)	Range lbf·in/lbf·ft	Square drive mm	Total length mm	Dimensions (mm)						Weight kg
									Head			Body			
								H	G	R	A	B	C		
60QSPK	20~60	N60QSPK	N6QSPK	2~6	PI 60QSPK	20~60	6.35 (1/4")	174	19.5	7.5	12.5	18.2	9.6	15	0.17
120QSPK	40~120	N120QSPK	N12QSPK	4~12	PI 120QSPK	40~120	9.53 (3/8")	220	25	12	16				25
230QSPK	70~230	N230QSPK	N25QSPK	7~23	PI 230QSPK	70~230		240				340	31	14	
250QSPK	70~250	N250QSPK	N25QSPK	7~25	PI 450QSPK	100~450	12.7 (1/2")	380	33	20	23				34
450QSPK	100~450	N450QSPK	N50QSPK	10~45	PI 1800QSPK	400~1800						19.05 (3/4")	664	42	
500QSPK	100~500	N500QSPK	N50QSPK	10~50	PI 1800QSPK	400~1800	463.5	49.5	49.5	20	34				43.5
900QSPK	200~900	N900QSPK	N200QSPK	20~90	PI 2800QSPK	600~2800	980					380	33	20	
1000QSPK	200~1000	N1000QSPK	N100QSPK	20~100	PF 300QSPK	50~300	980	380	33	20	23				34
1400QSPK	400~1400	N1400QSPK	N140QSPK	40~140											
1800QSPK	400~1800	N1800QSPK	N200QSPK	40~200											
2000QSPK	400~2000	N2000QSPK	N280QSPK	60~280											
2800QSPK	600~2800	N2800QSPK	N280QSPK	60~280											
4200QSPK	600~4200	N4200QSPK	N420QSPK	60~420											

QSPKH, QSPK-A PRE-SET, RATCHET TORQUE WRENCHES WITH PLASTIC GRIP

Pre-set torque value. Improved work efficiency with ratchet square drive.

FEATURES

- The ratchet drive enables quickly tightening fasteners to the preset torque. Suitable for repetitive jobs.
- The wrench's inner mechanism automatically resets itself for the the next job after disengaging from a tightened joint.
- Accuracy : ±3% of set value.



(N)60~1400QSPKH, QSPK-A (with Rubber Grip)

■ H-type : The end cap is removed with a slotted screwdriver to adjust torque.

Model (kgf·cm)	Range kgf·cm	Old Model (N·m)	New Model (N·m)	Range N·m	Square drive mm	Total length mm	Dimensions (mm)						Weight kg
							Head			Body			
							H	G	R	A	B	C	
60QSPKH	20~60	N60QSPKH	N6QSPKH	2~6	6.35 (1/4")	174	19.5	7.5	12.5	18.2	9.6	26.5	0.19
120QSPKH	40~120	N120QSPKH	N12QSPKH	4~12	9.53 (3/8")	220	25	12	16				25
250QSPKH	70~250	N250QSPKH	N25QSPKH	7~25		240				340	31	14	
500QSPKH	100~500	N500QSPKH	N50QSPKH	10~50	380	12.7 (1/2")	31	14	19.7				27.5
1000QSPKH	200~1000	N1000QSPKH	N100QSPKH	20~100									
1400QSPKH	400~1400	N1400QSPKH	N140QSPKH	40~140									

■ A-type : Adjusted setting torque value by hex wrench.

Model (kgf·cm)	Range kgf·cm	Old Model (N·m)	New Model (N·m)	Range N·m	Square drive mm	Total length mm	Dimensions (mm)						Weight kg
							Head			Body			
							H	G	R	A	B	C	
60QSPK-A	20~60	N60QSPK-A	N6QSPK-A	2~6	6.35 (1/4")	174	19.5	7.5	12.5	18.2	9.6	26.5	0.19
120QSPK-A	40~120	N120QSPK-A	N12QSPK-A	4~12	9.53 (3/8")	220	25	12	16				25
250QSPK-A	70~250	N250QSPK-A	N25QSPK-A	7~25		240				340	31	14	
500QSPK-A	100~500	N500QSPK-A	N50QSPK-A	10~50	380	12.7 (1/2")	31	14	19.7				27.5
1000QSPK-A	200~1000	N1000QSPK-A	N100QSPK-A	20~100									
1400QSPK-A	400~1400	N1400QSPK-A	N140QSPK-A	40~140									

Note : Use a KANON torque wrench analyzer when adjusting torque. Without the analyzer, torque cannot be adjusted.

* is the new model that is applied from 1st January, 2016.



QSPKH

* Adjusting tool is option



QSPK-A

* Hex wrench is option

SPCK PRE-SET, REPLACEABLE HEAD TORQUE WRENCHES

Work at a set torque value can proceed smoothly while using various replaceable heads.

FEATURES

- Replaceable ratchet, open end wrench, ring, and hex drive heads are available.
- Pre-set torque wrench well suited for repetitive jobs at the specified torque value.
- Accuracy : $\pm 3\%$ of pre-set value

USING AN SPCK

Mount the head on the drive.



SPCK
(Metal Handle)

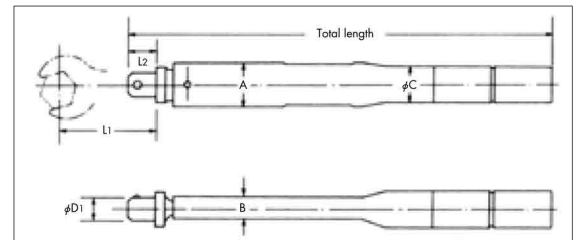

Model (kgf·cm)	Range kgf·cm	Old Model (N·m)	New Model (N·m)	Range N·m	Total length mm	Dimensions (mm)						Weight kg	Replaceable heads
						Head			Body				
60SPCK	20~60	N60SPCK	N6SPCK	2~6	161	10	45	13	18.2	9.6	15	0.15	120QCK,230 (SCK,RCK,HCK)
120SPCK	40~120	N120SPCK	N12SPCK	4~12									
230SPCK	70~230	N230SPCK	N25SPCK	7~23	196	10	45	13	18.2	9.6	15	0.19	230 (QCK,SCK,RCK,HCK)
250SPCK	70~250	N250SPCK	N25SPCK	7~25									
450SPCK	100~450	N450SPCK	N50SPCK	10~45	220	12	55	16	25	11.4	20	0.27	450 (QCK,SCK,RCK,HCK)
500SPCK	100~500	N500SPCK	N50SPCK	10~50									
900SPCK	200~900	N900SPCK	N100SPCK	20~90	312	15	65	18	27.5	12.4	21.7	0.57	900 (QCK,SCK,RCK,HCK)
1000SPCK	200~1,000	N1000SPCK	N100SPCK	20~100									
1800SPCK	400~1,800	N1800SPCK	N200SPCK	40~180	428	18	80	22	34	15.4	27.2	0.92	1800 (QCK,SCK,RCK,HCK)
2000SPCK	400~2,000	N2000SPCK	N280SPCK	40~200									
2800SPCK	600~2,800	N2800SPCK	N280SPCK	60~280	590	22	100	27	38	16	30	1.7	2800 (QCK,SCK,RCK,HCK)
4400SPCK	600~4,400	N4400SPCK	N440SPCK	60~440									
					893				39			2.6	4400 (QCK,SCK,RCK)

SPCKH PRE-SET, REPLACEABLE HEAD TORQUE WRENCHES WITH PLASTIC GRIP

Work at a set torque value can proceed smoothly while using various replaceable heads.



(N)60~1000SPCKH
(with Rubber Grip)

Optional Replaceable Heads (Refer to the page 10)



Model (kgf·cm)	Range kgf·cm	Old Model (N·m)	New Model (N·m)	Range N·m	Total length mm	Dimensions (mm)						Weight kg	Replaceable heads
						Head			Body				
60SPCKH	20~60	N60SPCKH	N6SPCKH	2~6	161	10	45	13	18.2	9.6	26.5	0.17	120QCK,230 (SCK,RCK,HCK)
120SPCKH	40~120	N120SPCKH	N12SPCKH	4~12									
250SPCKH	70~250	N250SPCKH	N25SPCKH	7~25	196	10	45	13	18.2	9.6	26.5	0.21	230 (QCK,SCK,RCK,HCK)
500SPCKH	100~500	N500SPCKH	N50SPCKH	10~50									
1000SPCKH	200~1,000	N1000SPCKH	N100SPCKH	20~100	312	15	65	18	27.5	12.4	37	0.62	900 (QCK,SCK,RCK,HCK)

RE-SETTING THE PRE-SET TORQUE

(SPK · RSPK · QSPK · SPCK · TYPES)

- (1) Remove the screw cap with a slot drive screw driver.
- (2) Loosen the setting screw with a hex wrench.
- (3) Using the special adjusting tool or equivalent, rotate the slotted plate clockwise to increase torque or counterclockwise to reduce torque. Check the setting with a torque analyzer.
- (4) Tighten the setting screw with a hex wrench.
- (5) Screw on the screws cap and tighten it.

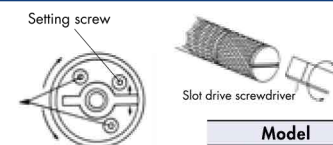

★ Adjusting tools



Model	Applicable Torque wrench Tools
Adjusting Tool No.1	(N)30,80,190SPK(H), (N)30,80,190RSPK(H), (N)60,120,230,250QSPK(H)
Adjusting Tool No.2	(N)380,670SPK(H), (N)380,670RSPK(H), (N)450,500,900,1000,1400QSPK(H)
Adjusting Tool No.3	(N)1200,1600,2200SPK, (N)1200,1600,2200RSPK, (N)1800,2000QSPK, (N)2800 QSPK
Adjusting Tool No.4	(N)3100SPK, (N)3100RSPK, (N)4200QSPK
Adjusting Tool No.5	(N)4200SPK, (N)4200RSPK

* Adjusting tool is option.

* is the new model that is applied from 1st January, 2016.

LCK **ADJUSTABLE, REPLACEABLE HEAD TORQUE WRENCHES**

Freely replace heads according to work applications. The combination of replaceable heads and torque adjustability make this series extremely versatile.

FEATURES

- Ring, ratchet, open end wrench and hex drive heads are available.
- The torque can be set to any value within the capacity range.
- Models are available ranging from 20 kgf-cm to 14,000 kgf-cm.
- Accuracy : $\pm 3\%$ of indicated value over the full range

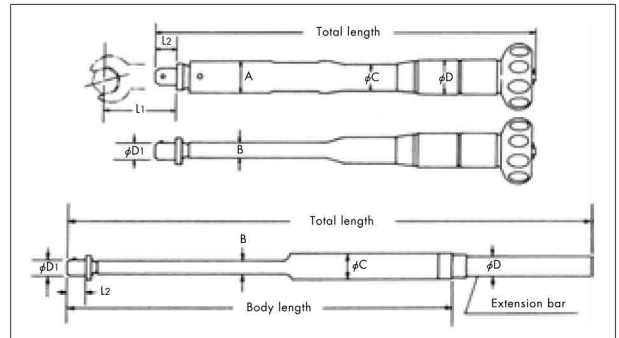

Model (kgf-cm/kgf-m)	Range kgf-cm/kgf-m	Increment kgf-cm/kgf-m	Old Model (N-m)	New Model (N-m)	Range N-m	Increment N-m	Total length mm	Dimensions (mm)								Weight kg	Replaceable heads	
								Head			Body							
60LCK	20 ~ 60	1	N60LCK	N6LCK	2 ~ 6	0.1	173	10	45	13	18.2	9.6	15			0.17	120QCK,230	
120LCK	40 ~ 120	2	N120LCK	N12LCK	4 ~ 12	0.2											SCK,RCK HCK	
230LCK	70 ~ 230	2	N230LCK	N25LCK	5 ~ 25	0.2											208	0.2
450LCK	100 ~ 450	5	N450LCK	N50LCK	10 ~ 50	0.5	232	12	55	16	25	11.4	20			0.36	450 (QCK,SCK,RCK,HCK)	
900LCK	200 ~ 900	10	N900LCK	N100LCK	20 ~ 100	1	325	15	65	18	27.5	12.4	21.7				0.59	900 (QCK,SCK,RCK,HCK)
1800LCK	400 ~ 1,800	20	N1800LCK	N200LCK	40 ~ 200	2	443	18	80	22	34	15.4	27.2				1.3	1800 (QCK,SCK,RCK,HCK)
2800LCK	4 ~ 28	0.2	N2800LCK	N280LCK	40 ~ 280	2	648	22	100	27	35	39	16	30			1.8	2800 (QCK,SCK,RCK,HCK)
4400LCK	6 ~ 44	0.2	N4400LCK	N440LCK	60 ~ 440	2	908										4.1	4400 (QCK,SCK,RCK,HCK)
5600LCK	8 ~ 56	0.3	N5600LCK	N560LCK	80 ~ 560	3	1086	30	125	45	43.5	18	34				2.8	4400 (QCK,SCK,RCK,HCK)
7000LCK	10 ~ 70	0.5	N7000LCK	N700LCK	100 ~ 700	5	1206										46	19.2
8500LCK	10 ~ 85	0.5	N8500LCK	N850LCK	100 ~ 850	5	1267	34	130	47	54	23	42.7	31.8			7.2	10000 (QCK,SCK,RCK)
10000LCK	10 ~ 100	0.5	N10000LCK	N1000LCK	100 ~ 1,000	5	1417										7.5	10000 (QCK,SCK,RCK)
14000LCK	20 ~ 140	1	N14000LCK	N1500LCK	200 ~ 1,500	10	1700	38	160	60	66	26	51	40	1003	13.5	14000 (QCK,SCK,RCK)	

GCK **ADJUSTABLE, REPLACEABLE HEAD TORQUE WRENCHES WITH PLASTIC GRIP**

Freely replace heads according to work applications. The combination of replaceable heads and torque adjustability make this series extremely versatile.

FEATURES

- Ring, ratchet, open end wrench and hex drive heads are available.
- The torque can be set to any value within the capacity range.
- Models are available ranging from 20 kgf-cm to 1,400 kgf-cm.
- Accuracy : $\pm 3\%$ of indicated value over the full range

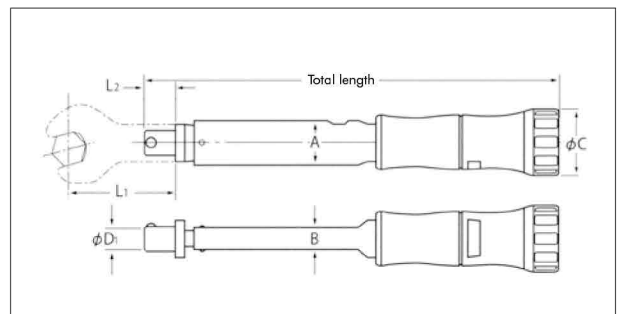

Model (kgf-cm)	Range kgf-cm	Increment kgf-cm	Model (N-m)	Range N-m	Increment N-m	Total length mm	Dimensions (mm)						Weight kg	Replaceable heads
							Head			Body				
60GCK	20~60	1	N6GCK	2~6	0.1	174	10	45	13	18.2	9.6	29	0.18	120QCK,230
120GCK	40~120	2	N12GCK	4~12	0.2									SCK, RCK HCK
250GCK	50~250	2	N25GCK	5~25	0.2									209
500GCK	100~500	5	N50GCK	10~50	0.5	235	12	55	16	25	11.4	35	0.37	450 (QCK, SCK, RCK, HCK)
1000GCK	200~1,000	10	N100GCK	20~100	1	327	15	65	18	27.5	12.4	38	0.6	900 (QCK, SCK, RCK, HCK)
1400GCK	400~1,400	20	N140GCK	40~140	2	365								

* is the new model that is applied from 1st January, 2016.

HEADS

OPTIONAL REPLACEABLE HEADS

SCK (Open End head)

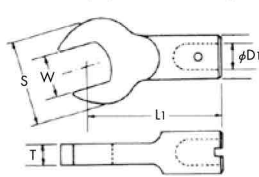

QCK (Ratchet head)

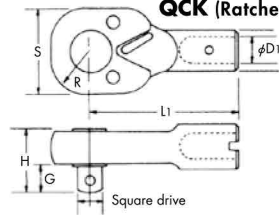

RCK (Ring head)

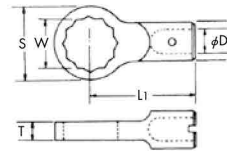

HCK (Hex drive head)

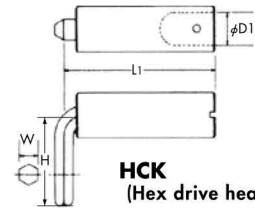

SCK open end heads

Unit : mm

Old Model	New Model	Size (W)					S	T	L1	φD1	Applicable torque wrench
		7	8	9	10	11					
230SCK	25SCK	7	8	9	10	11	29	7	45	10	[N]40-230LCK DTC-P80EXL [N]60-250SPCK DTC-N5EXL DTC-50EXL DTC-N10EXL DTC-100EXL 250GCK DTC-P400EXL N25GCK
		12	13	14	15	16	32				
		17	19	21	22	24	39				
		24					45				
		8	9	10	11		32				
450SCK	50SCK	12	13	14	15	16	36	10	55	12	[N]450LCK DTC-N50EXL [N]450-500SPCK 500GCK DTC-500EXL N50GCK DTC-P400EXL DLF-N50-UC
		17	19	21	22		44				
		24	27				50				
		12	13	14	15		40				
900SCK	100SCK	16	17	19	21	22	48	12	65	15	[N]900LCK 1000GCK [N]900-1000SPCK N100GCK DTC-1000EXL 1400GCK DTC-P800EXL N140GCK DTC-N100EXL DLF-N100-UC
		24	27	30			57				
		17	19	21	22		56				
1800SCK	200SCK	24	27	30			64	14	80	18	[N]1800LCK DTC-PF100EXL [N]1800-2000SPCK DTC-N200EXL DTC-2000EXL DLF-N200-UC
		32	36	41			75				
		19					59				
2800SCK	280SCK	21	22				61	16	100	22	[N]2800LCK DTC-PF200EXL [N]2800SPCK DTC-N300EXL DTC-3000EXL
		24					63				
		27					67				
		30					69				
		32					71				
		36					75				
		41					80				
		46					85				
4400SCK	440SCK	19	22	24			78	20	100	22	[N]4400LCK [N]4400SPCK
		27	30	32			84				
		36	41				94				
		55	60				100				
		27					83				
7000SCK	700SCK	30					86	25	125	30	[N]5600-7000LCK DTC-PF400EXL DTC-5000EXL DTC-N500EXL
		32					88				
		36					91				
		41					95				
		46					98				
		50					102				
		55					105				
10000SCK	1000SCK	60					110	30	130	34	[N]8500-10000LCK DTC-PF800EXL DTC-10000EXL DTC-N1000EXL
		36					95				
		41					100				
		46					106				
		50					110				
14000SCK	1500SCK	55					115	35	160	38	[N]14000LCK
		60					120				
		41					110				
		46					115				
		50					120				
		55					122				

QCK ratchet heads

Unit : mm

Old Model	New Model	Sq. drive	S	H	G	R	L1	φD1	Applicable torque wrench
120QCK	12QCK	6.35 (1/4")	24	19	7.5	12	45	10	[N]40-230LCK DTC-N5EXL [N]60-250SPCK DTC-N10EXL DTC-50EXL DTC-100EXL DTC-P400EXL N25GCK
230QCK	25QCK	9.53 (3/8")	31	25	11	15.5	55	12	[N]450LCK DTC-N50EXL [N]450-500SPCK 500GCK DTC-500EXL DTC-P400EXL DTC-N50EXL N50GCK
450QCK	50QCK	12.7 (1/2")	39	31	14	19.7	65	15	[N]900LCK [N]900-1000SPCK DTC-1000EXL 1400GCK DTC-P800EXL N140GCK DTC-N100EXL DLF-N100-UC
900QCK	100QCK	12.7 (1/2")	46	33	14	23	80	18	[N]1800LCK [N]1800-2000SPCK DTC-2000EXL DTC-PF100EXL DTC-N200EXL DLF-N200-UC
1800QCK	200QCK	19.05 (3/4")	54	42.5	20	27	100	22	[N]2800LCK SPCK DTC-PF200EXL DTC-3000EXL DTC-N300EXL
2800QCK-A	280QCK-A	19.05 (3/4")	68	50		34	125	30	[N]4400LCK, [N]4400SPCK
4400QCK	440QCK		76	58	27	38	130	34	[N]5600LCK [N]5600SPCK DTC-PF400EXL DTC-N500EXL DTC-5000EXL DTC-N500EXL
7000QCK	700QCK		87	61	28.5	43.5	160	38	[N]8500LCK [N]8500SPCK DTC-10000EXL DTC-N1000EXL
10000QCK	1000QCK	25.4 (1")							[N]14000LCK

* is the new model that is applied from 1st January, 2016.

RCK ring heads

Unit : mm

Old Model	New Model	Size (W)					S	T	L1	φD1	Applicable torque wrench
		7	8	9	10	11					
230RCK	25RCK	7	8	9	10	11	18	8	45	10	[N]60-230LCK DTC-P80EXL [N]60-250SPCK DTC-N5EXL DTC-100EXL DTC-N10EXL DTC-500EXL 250GCK DTC-P400EXL N25GCK
		12	13	14			21				
		17	19	22	24		31				
		8	10				19				
450RCK	50RCK	11	12	13	14		19	10	55	12	[N]450LCK DTC-N50EXL [N]450-500SPCK 500GCK DTC-500EXL N50GCK DTC-P400EXL DLF-N50-UC
		17	19	22			32				
		12	13	14			25				
900RCK	100RCK	17	19	21	22	24	34	13	65	15	[N]900LCK 1000GCK [N]900-1000SPCK N100GCK DTC-1000EXL 1400GCK DTC-P800EXL N140GCK DTC-N100EXL DLF-N100-UC
		24	27	30			42				
		17	19	22			35				
1800RCK	200RCK	24	27	30			45	15	80	18	[N]1800LCK DTC-PF100EXL [N]1800-2000SPCK DTC-N200EXL DTC-2000EXL DLF-N200-UC
		32	36	41			58				
		19	22	24			40				
2800RCK	280RCK	27	30	32			47	17	100	22	[N]2800LCK SPCK DTC-PF200EXL DTC-3000EXL DTC-N300EXL
		36	41				63				
		46					20				
		19	22	24			44				
4400RCK	440RCK	27	30	32			50	20	100	22	[N]4400LCK [N]4400SPCK
		36	41				58				
		46	50				66				
		55	60				80				
		27	30	32			57				
		41					62				
7000RCK	700RCK	46	50				70	25	125	30	[N]5600-7000LCK DTC-PF400EXL DTC-5000EXL DTC-N500EXL
		55					80				
		60					30				
		36					65				
		41					28				
10000RCK	1000RCK	46					72	30	130	34	[N]8500-10000LCK DTC-PF800EXL DTC-10000EXL DTC-N1000EXL
		50					80				
		55					30				
		60					33				
		41					27				
		46					75				
14000RCK	1500RCK	50					80	32	160	38	[N]14000LCK
		55					90				
		60					35				
		65					35				

HCK hex drive heads

Unit : mm

Old Model	New Model	Size (W)	L1	φD1	Size (H)	Applicable torque wrench
230HCK	25HCK	2.5	45	10	19	[N]60-230LCK DTC-P80EXL [N]60-250SPCK DTC-N5EXL DTC-100EXL DTC-N10EXL DTC-500EXL 250GCK DTC-P400EXL N25GCK
		3			22	
		4			25	
		5			30	
		6			35	
		8			40	
450HCK	50HCK	4	55	12	27	[N]450LCK DTC-N50EXL [N]450-500SPCK 500GCK DTC-500EXL N50GCK DTC-P400EXL DLF-N50-UC
		5			30	
		6			35	
		8			40	
		10			45	
		10			45	
900HCK	100HCK	6	65	15	35	[N]900LCK 1000GCK [N]900-1000SPCK N100GCK DTC-1000EXL 1400GCK DTC-P800EXL N140GCK DTC-N100EXL DLF-N100-UC
		8			40	
		10			45	
		12			51	
		14			63	
		14			63	
1800HCK	200HCK	8	80	18	40	[N]1800LCK DTC-PF100EXL [N]1800-2000SPCK DTC-N200EXL DTC-2000EXL DLF-N200-UC
		10			45	
		12			51	
		14			63	
		17			72	
		12			51	
2800HCK	280HCK	14	100	22	63	[N]2800LCK SPCK DTC-PF200EXL DTC-3000EXL DTC-N300EXL
		17			71	
		19			80	

QLK-LR LARGE HUB NUT TORQUE WRENCHES

Ideal for tightening hub nuts on large trucks and buses

FEATURES

- Dual square drives for both clockwise and counterclockwise tightening.
- By replacing the sockets, various sizes of fasteners can be tightened within the tool's capacity range.
- By reversing the switch on the ratchet, the wrench can be used to loosen fasteners. Tightening to a torque setting, however, can only be done in the direction of the arrow.
- Accuracy : $\pm 3\%$ of indicated value over the full range

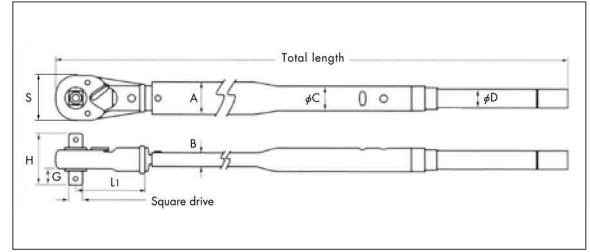

Model (kgf·m)	Range	Increment	Old Model (N·m)	New Model (N·m)	Range	Increment	Square drive	Total length	Dimensions (mm)								Weight	Standard Accessory
									Head				Body					
	kgf·m				N·m		mm	mm	S	G	H	L ₁	A	B	φC	φD	kg	
7000QLK-LR	10~70	0.5	N7000QLK-LR	N700QLK-LR	100~700	5	19.05 (3/4")	1,314	68	20	70	125	49	20	35.4	27.2	6.2	Torque adjusting, box wrench
8500QLK-LR	10~85		N8500QLK-LR	N850QLK-LR	100~850		25.4 (1")	1,388	76	27	85	168	54	23	42.7	31.8	8.5	
10000QLK-LR	10~100		N10000QLK-LR	N1000QLK-LR	100~1000		1,538	76	27	85	168	54	23	42.7	31.8	8.8		



Old Model (Replaceable Head)	New Model (Replaceable Head)	Square drive	Applicable torque wrench
7000QCK-LR	700QCK-LR	19.05 (3/4")	(N)5600~7000LCK
10000QCK-LR	1000QCK-LR	25.4 (1")	(N)8500~10000LCK

HYK ADJUSTABLE WRENCH HEADS, ADJUSTABLE TORQUE WRENCHES

Built-in "no play" worm screw

FEATURES

- Since the head can be taken off and reversed, the wrench can be used in confined spaces (in as small as a 30 degree turn) previously inaccessible to even other adjustable wrenches. (Tightening to a torque setting can only be done in the direction of the arrow.)
- There is hardly any play in the worm screw adjuster in the wrench head, which will improve your working efficiency. Without excess play, the torque wrench will not damage the corners of fasteners like ordinary wrenches will.
- Accuracy : $\pm 4\%$ of indicated value over the full range

USING AN HYK

■ Setting the opening

- (1) Slide the jaws onto the fastener until it contacts the spring pin. (a)
- (2) Tighten the adjusting worm screw so the jaws grip the fastener. (b)
- (3) Loosen the adjusting worm screw just enough to allow removing the wrench from the fastener. (c)

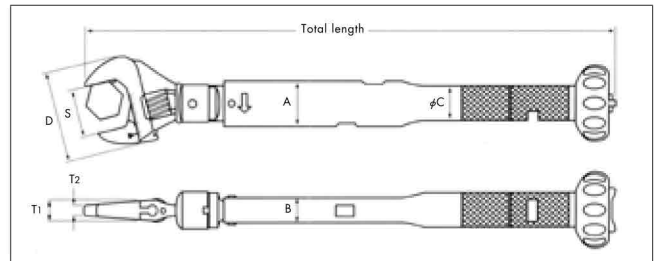
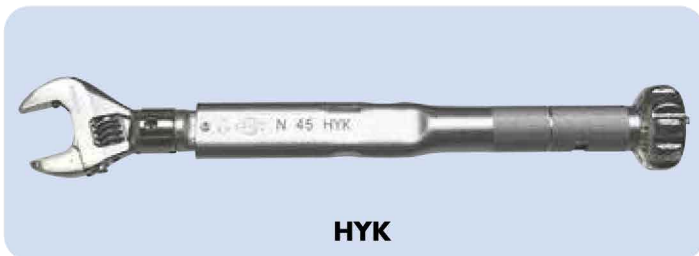
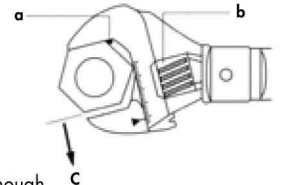

Model (kgf·cm)	Range	Increment	Model (N·m)	Range	Increment	Total length	Opening Size (mm)	Dimensions (mm)							Weight
								Head				Body			
	kgf·cm			N·m		mm	S	D	T ₁	T ₂	A	B	φC	g	
450HYK	100~450	5	N45HYK	10~45	0.5	285	10~25	48	10	5.5	25	11.4	20	460	
900HYK	200~900	10	N90HYK	20~90	1	386	10~30	58	12	6.0	27.5	12.4	21.7	740	
1800HYK	400~1800	20	N180HYK	40~180	2	518	17~38	66	12.5	6.5	34	15.4	27.2	1,420	

■ MCK

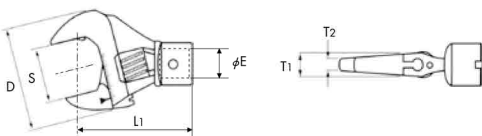

Model (Replaceable Head)	Opening Size (mm)	Dimensions (mm)					Applicable torque wrench
	S	D	φE	L ₁	T ₁	T ₂	
45MCK	10~25	48	12	57	10	5.5	(N)450LCK, (N)450-500SPCK, 500GCK, DTC-500EXL, DTC-9400EXL, DTC-NS0EXL, NS0GCK
90MCK	10~30	58	15	65	12	6	(N)900LCK, (N)900-1000SPCK, DTC-1000EXL, N1000GCK, DTC-9800EXL, DTC-N1000EXL, 1000GCK, N1200GCK
180MCK	17~38	66	18	80	13	6.5	(N)1800LCK, (N)1800-2000SPCK, DTC-N2000EXL, DTC-2000EXL, DTC-PF1000EXL, NS0GCK

* is the new model that is applied from 1st January, 2016.

DLT-N KANON DIGITAL TORQUE WRENCH

Digital control for ease of use and handling. Precise control of torque at a low cost.



Optional Replaceable Heads (Refer to the page 10)



SCK
(Open End head)



RCK
(Ring head)



HCK
(Hex drive head)

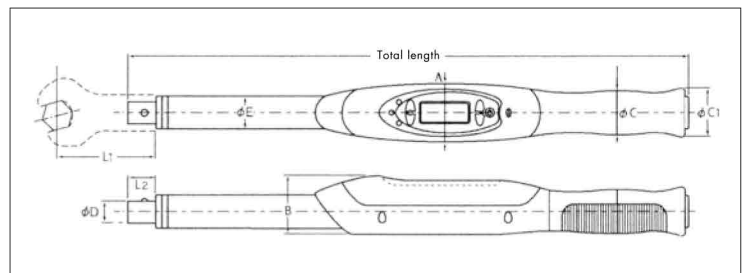

FEATURES

- The digital torque wrench DLT-N series measures and digitally displays tightening torque and return torque.
- Preset function: Set the tightening torque before operation, and the LED and a buzzer tell you when the preset torque is reached during operation.
- Data memory function: Connect the torque wrench after use to your PC, and the measurement data is stored in the PC for editing in the Excel format (Windows Excel only).
- Powered by 2 rechargeable nickel-metal hydride (Ni-MH) batteries, which are recharged via the USB port of the torque wrench while they are in the wrench.
- Auto power-off: Saves power to enable use of the unit for a longer time.
- Calendar function: Date and time of tightening operations are stored in the memory.
- Smart and slim design based on a new concept.
- The head is easily replaceable to suit different purposes of use.
- $\pm 2\%$ + 1 digit guaranteed accuracy ($\pm 3\%$ + 1 digit for DLT-N50-UC).

Names and Functions of Components



- ① Power key Power ON/OFF; clears measured value in PA mode.
- ② Data key Saves and calls data.
- ③ Mode key Selects the measurement mode.
- ④ UP key Sets tightening torque in the preset mode; searches a particular data in the data calling mode; sets calendar and clock.
- ⑤ DOWN key Sets tightening torque in the preset mode; searches a particular data in the data calling mode; sets calendar and clock.
- ⑥ LED Flashes to indicate that the preset torque is soon to be reach; an intermittent buzzer sounds. Lights up to indicate that the preset torque has been reached; a continuous buzzer sounds.
- ⑦ LCD display Displays various data.
- ⑧ USB terminal For battery charging and data outputting (Windows only).

Model	Range	Increment	Total length	Dimensions (mm)									Weight	Accessory
				Head			Body							
			mm	ϕD_1	L1	L2	A	B	ϕC	ϕC_1	ϕE	kg		
DLT-N50-UC	10.00~50.00 N·m	0.01 N·m	411	12	55	15	47	47	37	40	27.2	0.8	450QCK	
	7.38~36.87 ft·lb	0.01 ft·lb												
	88.5~442.5 in·lb	0.1 in·lb												
DLT-N100-UC	20.0~100.0 N·m	0.1 N·m	413	15	65	17	47	47	37	40	27.2	0.9	900QCK	
	14.8~73.8 ft·lb	0.1 ft·lb												
	177~885 in·lb	1 in·lb												
DLT-N200-UC	2.04~10.19 kgf·m	0.01 kgf·m	457	18	80	22	47	47	37	40	27.2	1	1800QCK	
	40.0~200.0 N·m	0.1 N·m												
	29.6~147.5 ft·lb	0.1 ft·lb												
	354~1770 in·lb	1 in·lb												
	4.08~20.38 kgf·m	0.01 kgf·m												

[Common Specifications for DLT-N Series]

Accuracy	Data memory	Measurement mode	Alarm mode	Measurement method	Power source	Use time	Charge time	Auto power off	I/O terminal	Operating temperature range
$\pm 2\%$ + 1 digit ($\pm 3\%$ + 1 digit for DLT-N50)	999 data	RUN, PA, PC	LED and buzzer	CW/CCW auto switching	Ni-MH rechargeable batteries, size AA, 1.2V; 2 pieces	Approx. 20 hours with fully charged batteries (continuous use)	Max 5 hours. (approx.) for discharge and charge	After 60 seconds	USB terminal (for Windows) for data outputting and battery charging	+5~+35°C

RUN : Current load value is shown continuously PA : The first peak value is detected and held. PC : Peak-to-peak and auto start

FK INDICATOR PLATE TORQUE WRENCHES

Quite suitable for general tightening and for checking torque on previously tightened joints. A popular series with fan-shaped indicator plate scales.

FEATURES

- The simple structure and small friction area give this series of tools a long life.
- Strong and easy to handle.
- Accuracy : $\pm 3\%$ of indicated value over the full range

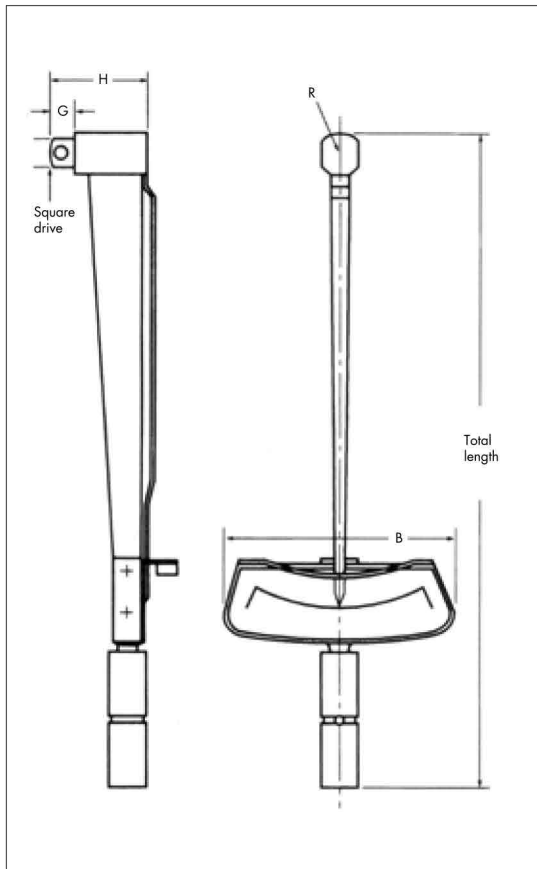

Model (kgf·cm)	Range (CW/CCW) kgf·cm	Increment	Old Model (N·m)	New Model (N·m)	Range (CW/CCW) cN·m/N·m	Increment	Sq. drive mm	Total length mm	Dimensions (mm)				Weight kg
									Head			Body	
								H	G	R	B		
4FK	1~4	0.2	N4FK	CN40FK	10~40 cN·m	2 cN·m	6.35 (1/4")	110	26	7.5	5	54	0.05
7FK	1~7	0.2	N7FK	CN70FK	10~70 "	2 "		132				0.05	
15FK	5~15	0.5	N15FK	CN150FK	50~150 "	5 "		140				0.08	
30FK	10~30	1	N30FK	N3FK	1~3 N·m	0.1 N·m		170				0.1	
60FK	10~60	2	N60FK	N6FK	1~6 "	0.2 "		190				0.22	
120FK	20~120	5	N120FK	N12FK	2~12 "	0.5 "		237				0.25	
230FK	30~230	5	N230FK	N23FK	3~23 "	0.5 "	290	0.3					
450FK	50~450	10	N450FK	N45FK	5~45 "	1 "	320	0.34					
900FK	100~900	20	N900FK	N90FK	10~90 "	2 "	388	1.1					
1300FK	200~1,300	20	N1300FK	N130FK	20~130 "	2 "	441	1.2					
1800FK	300~1,800	50	N1800FK	N180FK	30~180 "	5 "	487	1.3					
2800FK	500~2,800	50	N2800FK	N280FK	50~280 "	5 "	587	2.6					
4200FK	700~4,200	100	N4200FK	N420FK	70~420 "	10 "	853	3.5					
5600FK	1,000~5,600	100	N5600FK	N560FK	100~560 "	10 "	946	4.4					
7000FK	1,000~7,000	100	N7000FK	N700FK	100~700 "	10 "	1,172	6.7					
8500FK	1,500~8,500	200	N8500FK	N850FK	150~850 "	20 "	1,387	8.0					
10000FK	2,000~10,000	200	N10000FK	N1000FK	200~1,000 "	20 "	1,578	13.3					
15000FK	3,000~15,000	200	N15000FK	N1500FK	300~1,500 "	20 "	1,973	17.0					

* is the new model that is applied from 1st January, 2016.

TOK-G DIAL INDICATOR TORQUE WRENCHES

Easy to read dial indicator. Well suited for inspection and general maintenance service.



FEATURES

- Oval design with comfort rubber grip reduces strain.
- Easily readable for inspections.
- Useful for general tightening work.
- Accuracy : $\pm 3\%$ of indicated value over the full range

USING A TOK WRENCH

- (1) Turn the dial cap and set the indicator to 0.
 - (2) Mount a socket on the square drive.
 - (3) Tighten until the indicator points to the desired torque.
- * When using a peak indicator wrench, set it to 0 before tightening.

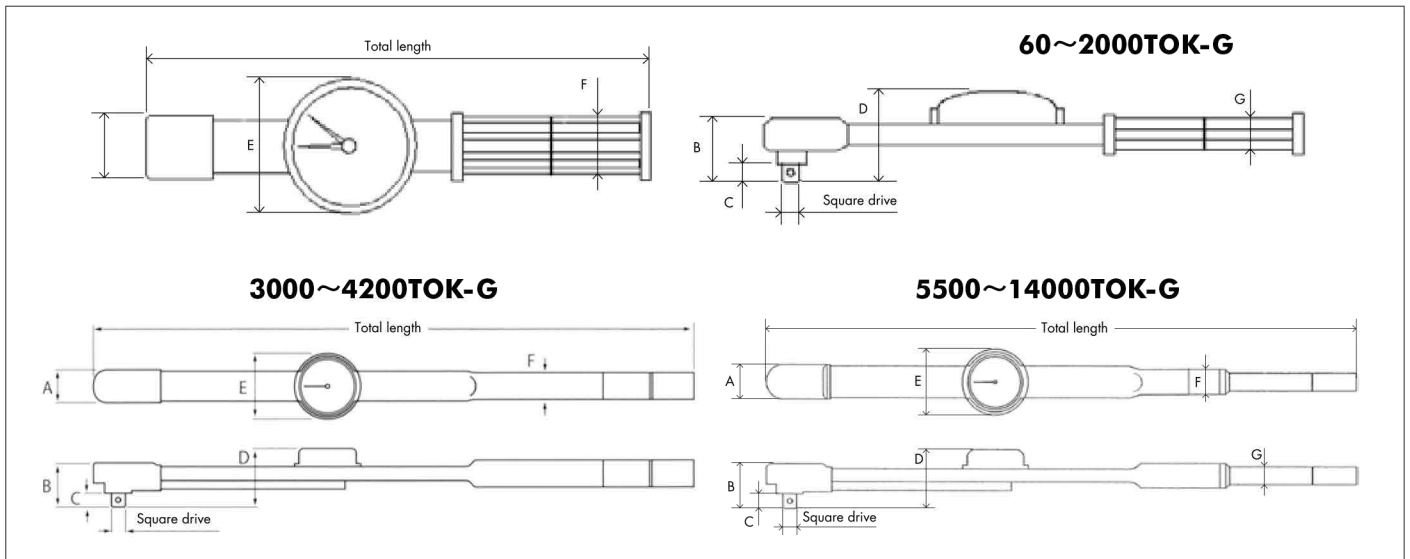

* 14000TOK-G and N1400TOK-G do not have the rubber head.

Model (kgf·cm/kgf·m)	Range (CW/CCW)	Increment	Model (N·m)	Range (CW/CCW)	Increment	Square drive	Total length	Dimensions (mm)							Weight kg
								Head			Body				
60TOK-G	6~60	kgf·cm	N 6TOK-G	0.6~6	0.1	6.35 (1/4")	260	A	B	C	D	E	F	G	0.5
120TOK-G	10~120	//	N 12TOK-G	1~12	0.2			35	38.5	7.5	58	90	37	21.5	
300TOK-G	50~300	//	N 30TOK-G	5~30	0.5	9.53 (3/8")	323	35	43	11	60	90	37	21.5	0.61
500TOK-G	50~500	//	N 50TOK-G	5~50	0.5			30	30	10~70	1				
700TOK-G	100~700	//	N 70TOK-G	10~70	1	12.7 (1/2")	463	39	49	14	65	90	41	22.5	0.87
1400TOK-G	200~1,400	//	N 140TOK-G	20~140	2			20	20	200~200	2				
2000TOK-G	200~2,000	//	N 200TOK-G	20~200	2	19.05 (3/4")	682	41	55	20	77	90	30	1.6	
3000TOK-G	3~30	kgf·m	N 300TOK-G	30~300	5			955	48		77		34	2.5	
4200TOK-G	4~42	//	N 420TOK-G	40~420	10	1,110	50	80	38	3.8					
5500TOK-G	5~55	//	N 550TOK-G	50~550	10	25.4 (1")	1,384	54	64	27	85	90	43	6.2	
7000TOK-G	7~70	//	N 700TOK-G	70~700	10			1,280	54		64		85	43	34
8500TOK-G	10~85	//	N 850TOK-G	100~850	10	1,384	58	72	93	45	34	7.1			
10000TOK-G	10~100	//	N 1000TOK-G	100~1,000	20	1,484	66	74	27	94	90	51	7.3		
14000TOK-G	20~140	//	N 1400TOK-G	200~1,400	20	1,696	66	74		94		51	40	9	

LTDK CLUTCH RELEASE TORQUE SCREW DRIVERS

Clutch release prevents over-tightening, reduces fatigue.

FEATURES

- Comfortable grip for extended use.
- Light weight and short overall length facilitates jobs.
Sensitive clutch release helps the operator feel when the torque setting is reached.
- Set the required torque value and tighten, all operators tighten consistently.
- Two Phillips bit are included.
- Various hex and box drive bits are available.
- Use for both clockwise and counter-clockwise tightening.
- Accuracy : $\pm 3\%$ of indicated value over the full range, clockwise.
- "H" models accept standard bits instead of CB type bits.

USING AN LTDK DRIVER

- (1) Select and mount a bit to match the fastener.
- (2) Rotate the adjusting ring and set the desired torque.
- (3) Tighten the fastener clock-wise until the clutch releases and there is no more resistance.



N6~50LTDK

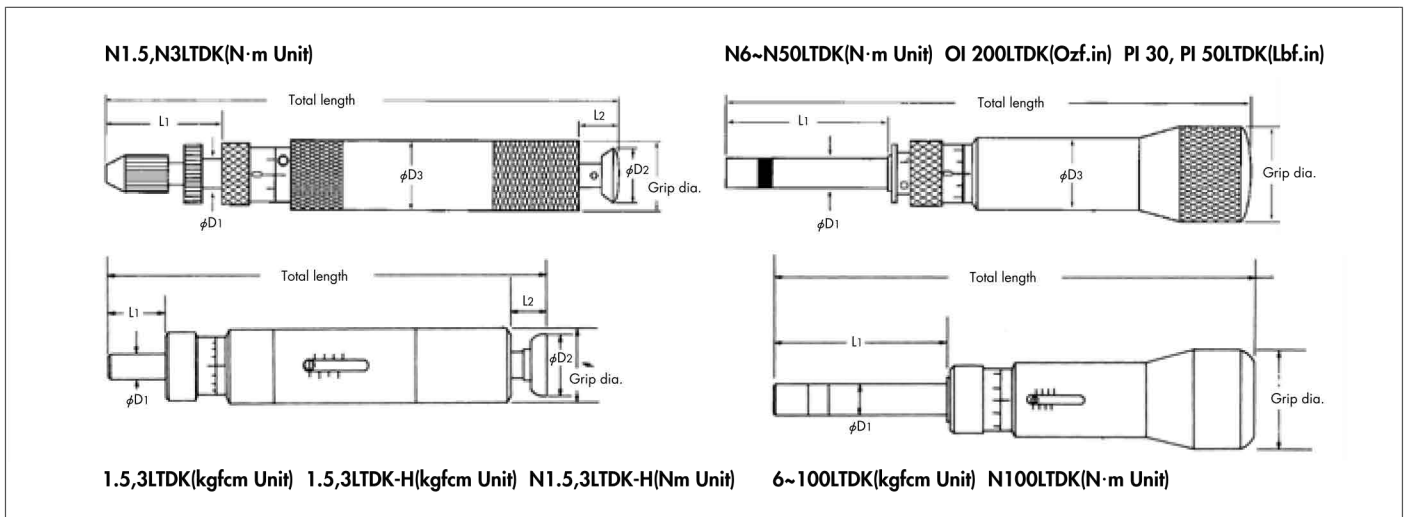

Old Model (cN·m/N·m)	New Model (cN·m/N·m)	Range	Increment	Model (ozf·in/lbf·in)	Range	Increment	Grip dia.	Total length (without bit)	Dimensions (mm)					Weight	Included Accessory			
									Body						Phillips	Bit type	Extension Bar	
cN·m/N·m				ozf·in/lbf·in				φmm	mm	L1	L2	φD1	φD2	φD3				g
N1.5LTDK	CN15LTDK	1 ~ 15	0.1				16	107	22	10.5	5.5	14.4	16	57	No.0	KANON bits CB type		
N3LTDK	CN30LTDK	2 ~ 30	0.2				25	110	26				20	99	No.1			
N6LTDK	CN60LTDK	5 ~ 60	0.5				30	157	51		10		25	192	No.0	Standard bits SB type	Included	
N12LTDK	CN120LTDK	20 ~ 120	1	OI 200LTDK	40 ~ 200	1	34						34	214	No.1			
N20LTDK	CN200LTDK	40 ~ 200	1	PI 30LTDK	4 ~ 30	0.1	40	200	63				34	436	No.2			
N30LTDK	CN300LTDK	40 ~ 300	1	PI 50LTDK	10 ~ 50	0.25	45	235	100		11		35	762	No.2, No.3			
N50LTDK	CN500LTDK	100 ~ 500	2.5				45	235	100				35	762	No.0			
N100LTDK	N10LTDK	4 ~ 10	0.05				16	111	26	9	10	14.4	35	60	No.1			
N1.5LTDK-H	CN15LTDK-H	1 ~ 15	0.1				16	111	26	9	10	14.4	35	60	No.1			
N3LTDK-H	CN30LTDK-H	2 ~ 30	0.2															

* is the new model that is applied from 1st January, 2016.

Model (kgf·cm)	Range	Increment		Grip dia.	Total length (without bit)	Dimensions (mm)					Weight	Included Accessory			
						Body						Bits		Extension Bar	
						L ₁	L ₂	φD ₁	φD ₂	φD ₃		g	Phillips		Bit type
1.5LTDK	0.1~1.5	kgf·cm	0.01	kgf·cm	16	99	14	9	5.5	14.4	20	95	No.0 No.1	KANON bits CB type	/
3LTDK	0.2~3	//	0.02	//											
6LTDK	0.5~6	//	0.05	//	25	110	35				25	190	No.0 No.1	Standard bits SB type	/
12LTDK	2~12	//	0.1	//											
20LTDK	4~20	//	0.1	//	34	157	57				34	208	No.1 No.2	Standard bits SB type	/
30LTDK	4~30	//	0.1	//											
50LTDK	10~50	//	0.25	//	40	200	73				35	436	No.2, No.3	Standard bits SB type	/
100LTDK	40~100	//	0.5	//											
1.5LTDK-H	0.1~1.5	//	0.01	//	16	111	26	9	10	14.4	35	762	No.0 No.1	Standard bits SB type	Included
3LTDK-H	0.2~3	//	0.02	//											

STDK PRE-SET TORQUE DRIVERS

Clutch release prevents over tightening.



FEATURES

- A single function driver, used for a single torque setting.
 - Most suited for tightening multiple same-size fasteners at the same torque in a production line.
 - Setting confirmation unnecessary.
 - Light weight and short overall length facilitates jobs.
Sensitive clutch release helps the operator feel when the torque setting is reached.
 - All operators tighten consistently.
 - Two Phillips bit are included.
 - Various hex and box drive bits are available.
 - Accuracy : ±3% of set value, clockwise.
- * Please specify required set torque when you order.

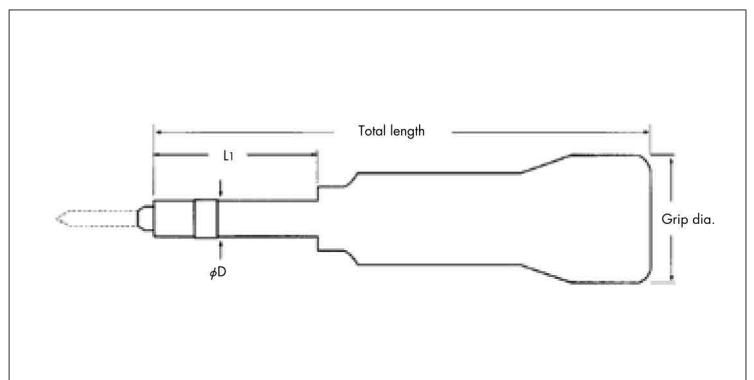

Model (kgf·cm)	Range	Old Model (cN·m/N·m)	New Model (cN·m/N·m)	Range	Model (ozf·in/lbf·in)	Range	Grip dia.	Total length (without bit)	Dimensions (mm)			Weight	Included Accessory		
									Body				Bits		Extension Bar
									L ₁	φD	g		Phillips	Bit type	
1.5STDK	0.1~1.5	N1.5STDK	CN15STDK	1~15 cN·m	OI 22STDK	2~22 ozf·in	16	92	22	8	45	No.0 No.1	KANON bits CB type	/	
3STDK	0.2~3	N3STDK	CN30STDK	2~30 //	OI 44STDK	4~44 //									
6STDK	0.5~6	N6STDK	CN60STDK	5~60 //	OI 80STDK	20~80 //	25	103	41	10	94	No.0 No.1	Standard bits SB type	/	
12STDK	2~12	N12STDK	CN120STDK	20~120 //	OI 200STDK	40~200 //									
20STDK	4~20	N20STDK	CN200STDK	40~200 //	PI 20STDK	4~20 lbf·in	30	116	54	35	170	No.1 No.2	Standard bits SB type	/	
30STDK	4~30	N30STDK	CN300STDK	40~300 //	PI 30STDK	4~30 //									
50STDK	10~50	N50STDK	CN500STDK	100~500 //	PI 50STDK	10~50 //	45	126	56	790	220	No.2, No.3	Standard bits SB type	Included	
100STDK	40~100	N100STDK	N10STDK	4~10 N·m	PI 100STDK	40~100 //									

* is the new model that is applied from 1st January, 2016.

DPSK DIAL GAUGE TORQUE DRIVERS

Suited for light torque, general tightening work, inspections. Easy to handle, easy to read scale.

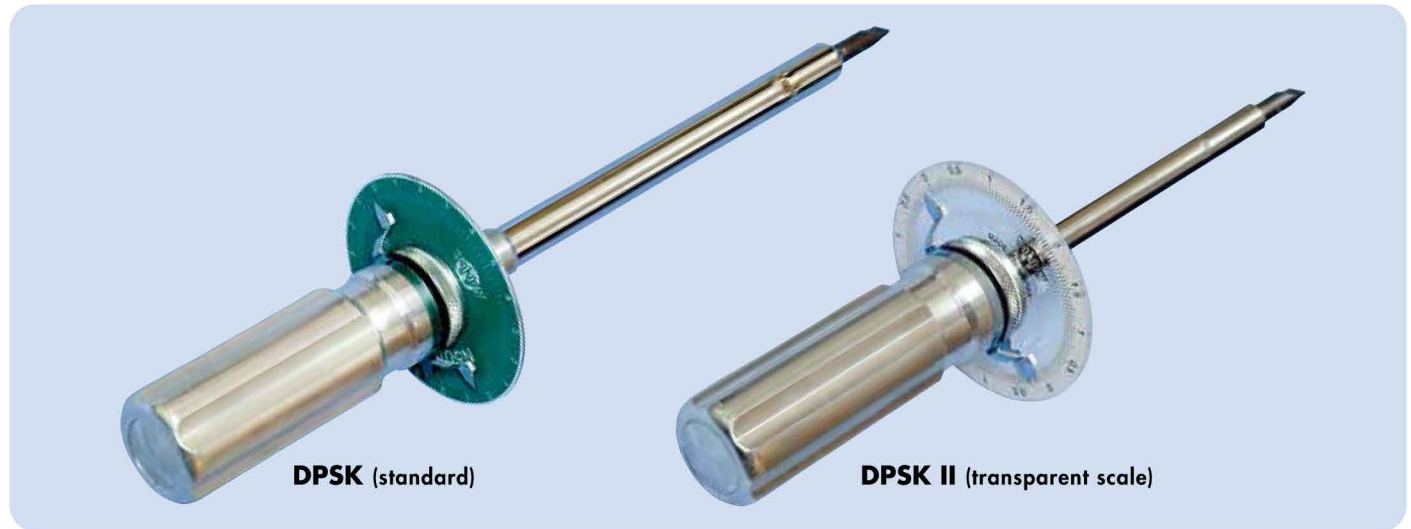

FEATURES

DPSK (standard)

- A light torque driver well suited for general tightening, inspections and break tests.
- Easy handling with a direct reading dial gauge.
- Use for both clockwise and counterclockwise tightening.
- Peak torque indicator works in both directions, too.
- Large, easily read dial gauge.

DPSK II (transparent scale)

- The transparent scale makes engaging the fastener easier.
- For both models, accuracy is $\pm 3\%$ of the indicated value over the full range

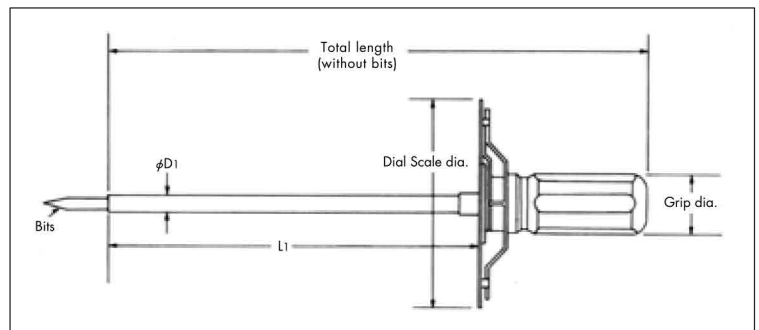

USING A DPSK DRIVER

- (1) Mount a bit matching the fastener being
- (2) Loosen the peak indicator ring.
- (3) Set the peak indicator to 0.
- (4) Tighten the fastener while observing the scale.

Model (kgf·cm)	Range (CW/CCW)	Increment	Old Model (cN·m/N·m)	New Model (cN·m/N·m)	Range (CW/CCW)	Increment	Dial dia. (mm)	Grip dia. (mm)	Total length (without bit) (mm)	Dimensions (mm)		Weight (kg)	Included Accessory Bits	
										Driver shaft (mm)	Weight (kg)		Phillips	Bit type
1DPSK	0.2~1	0.025	N 1DPSK	CN 10DPSK	2~10 cN·m	0.25 cN·m	78	22	217	152	6	0.075	No.0 No.1	KANON bits OB type
2DPSK	0.5~2	0.05	N 2DPSK	CN 20DPSK	5~20 //	0.5 //			195	130				
5DPSK	1~5	0.2	N 5DPSK	CN 50DPSK	10~50 //	2 //			208	143				
10DPSK	2~10	0.2	N 10DPSK	CN 100DPSK	20~100 //	2 //		33	222	130	12	0.33	No.1 No.2	Standard bits SB type
20DPSK	5~20	0.5	N 20DPSK	CN 200DPSK	0.5~2 N·m	0.05 N·m		36	242	188	14			
50DPSK	10~50	2	N 50DPSK	CN 500DPSK	1~5 //	0.2 //		78	300	188	14	0.47		
10DPSK(II)	2~10	0.2	N 10DPSK(II)	CN 100DPSK-L	20~100 cN·m	2 cN·m	33	222	130	12	0.29			
20DPSK(II)	5~20	0.5	N 20DPSK(II)	CN 200DPSK-L	0.5~2 N·m	0.05 N·m	36	242	188	14	0.32			
50DPSK(II)	10~50	2	N 50DPSK(II)	CN 500DPSK-L	1~5 //	0.2 //	78	300	188	14	0.42			

* is the new model that is applied from 1st January, 2016.

SGK TORQUE GAUGES

Capable of accurately measuring very low torque values.



* Peak indicator is optional

FEATURES

- Due to their miniature design and light weight, these gauges are convenient and easy to carry.
- A three part chuck with knurled surface enables firmly gripping even odd shapes.
- The inset scale face helps avoid incidental damage.
- The gauges measure clockwise and counterclockwise.
- With scales on the sides and the face, torque readings can be obtained either way.
- Accuracy : $\pm 3\%$ of the indicated value over the full range

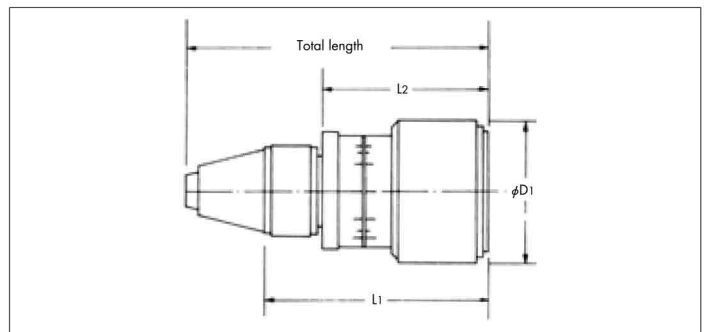

USING AN SGK GAUGE

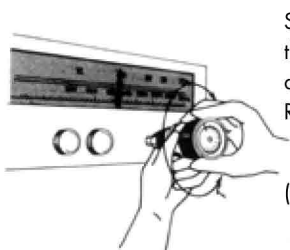

Starting torque can be measured with the chuck gripping a knob or shaft of an electronic device.

Rotate clockwise or counterclockwise.

(Rotate CW or CCW)



- If you would like SGK with a peak indicator, please specify "SGK-G" on your purchase order.
ex). N150(I)SGK-G

Three part chuck

Model (gf·cm/kgf·cm)	Range (CW/CCW) gf·cm/kgf·cm	Increment	Old Model (mN·m/cN·m)	New Model (mN·m/cN·m)	Range (CW/CCW) mN·m/cN·m	Increment	Chucking dia. φ mm	Total length mm	Dimensions (mm)			Weight kg
									Grip dia. φ D1	Total length (without chuck)		
										L1	L2	
90(I)SGK	10~90	2 gf·cm	N90(I)SGK	MN9SGK	1~9	0.2 mN·m	1~6.5	106	43	81	57.5	0.29
150(I)SGK	20~150	2	N150(I)SGK	MN15SGK	2~15	0.2						
300(I)SGK	40~300	5	N300(I)SGK	MN30SGK	4~30	0.5						
600(I)SGK	50~600	10	N600(I)SGK	MN60SGK	5~60	1						
1200(I)SGK	100~1,200	20	N1200(I)SGK	MN120SGK	10~120	2						
2400(I)SGK	200~2,400	50	N2400(I)SGK	MN240SGK	20~240	5						
1.5(II)SGK	0.1~1.5	0.02 kgf·cm	N1.5(II)SGK	CN15SGK	1~15	0.2 cN·m	1~8.5	134	63	100	73	0.6
2.4(II)SGK	0.2~2.4	0.02	N2.4(II)SGK	CN24SGK	2~24	0.2						
3.6(II)SGK	0.4~3.6	0.05	N3.6(II)SGK	CN36SGK	4~36	0.5						
6(II)SGK	0.5~6	0.1	N6(II)SGK	CN60SGK	5~60	1						
9(II)SGK	1~9	0.2	N9(II)SGK	CN90SGK	10~90	2						
15(II)SGK	1~15	0.2	N15(II)SGK	CN150SGK	10~150	2						

* is the new model that is applied from 1st January, 2016.

KDTA-SV DIGITAL TORQUE ANALYZERS

Enhanced digital processor system. Provides high performance with digital wrenches.

FEATURES

- LED display eliminates reading errors.
- Processor chip assures measurement with high reliability and accuracy.
- The display unit angle can be adjusted approximately 90°.
- Can be connected to various optional equipment (printer, personal computer, external input keyboard).
- Saves time and helps speed up work.
- Equipped with a kgf-cm/N-m selector switch.
- Operator can set min/max percentage parameters from 0–10%.
- Analyzer can indicate in or out of specification with a green or red lamp respectively.

SPECIFICATIONS

- Power source : AC100-240V 50/60Hz
- Accuracy : ±1% of the indicated value +1 increment, over the full range
- Display : red LED (character height : 25mm)
- Operating temperature : 0~40°C



KDTA-2000SV

Model	Range(CW/CCW)		Increment	English Model	Range(CW/CCW)		Increment	Measuring mode	Unit conversion	Dimensions (mm)			Drive size mm	Weight kg	Included Accessory													
	kgf-cm/kgf-m	N-m			lbf-in	N-m				Overall depth	Overall width	Overall height																
KDTA-20SV	2~20 kgf-cm	0.01 kgf-cm	KDTA-20SV	20~200 cN-m	0.1 cN-m	1.77~17.70 lbf-in	0.01 lbf-in	RUN Peak hold Peak to peak hold	Standard kgf-cm N-m	120	250	240	12	6	6.35×12 9.5×12 Socket													
	20~200 cN-m	0.1 cN-m			20~200 cN-m	0.1 cN-m																						
KDTA-100SV	10~100 kgf-cm	0.1 kgf-cm	KDTA-100SV	1~10 N-m	0.01 N-m	8.9~88.5 lbf-in	0.1 lbf-in									English Model lb-in N-m	180	320	273	14	15	9.5×14 12.7×14 Socket						
	1~10 N-m	0.01 N-m			1~10 N-m	0.01 N-m																						
KDTA-200SV	20~200 kgf-cm	0.1 kgf-cm	KDTA-200SV	17.7~177.0 lbf-in	0.1 lbf-in	2~20 N-m	0.01 N-m																220	380	265	26	25	19.05×26 12.7×26 Socket
	2~20 N-m	0.01 N-m			2~20 N-m	0.01 N-m																						
KDTA-1000SV	100~1000 kgf-cm	1 kgf-cm	KDTA-1000SV	10~100 N-m	0.1 N-m	89~885 lbf-in	1 lbf-in		30	25	30	30	25	19.05×30 25.4×30 Socket														
	10~100 N-m	0.1 N-m			10~100 N-m	0.1 N-m																						
KDTA-2000SV	200~2000 kgf-cm	1 kgf-cm	KDTA-2000SV	177~1770 lbf-in	1 lbf-in	20~200 N-m	0.1 N-m								30	25	30	30	25	19.05×30 25.4×30 Socket								
	20~200 N-m	0.1 N-m			20~200 N-m	0.1 N-m																						
KDTA-6000SV	600~6000 kgf-cm	1 kgf-cm	KDTA-6000SV	60~600 N-m	0.1 N-m	60~600 N-m	0.1 N-m														30	25	30	30	25	19.05×30 25.4×30 Socket		
	60~600 N-m	0.1 N-m			60~600 N-m	0.1 N-m																						
KDTA-10000SV	10~100 kgf-m	0.1 kgf-m	KDTA-10000SV	100~1000 N-m	1 N-m	100~1000 N-m	1 N-m	30	25	30	30	25	19.05×30 25.4×30 Socket															
	100~1000 N-m	1 N-m			100~1000 N-m	1 N-m																						

DRIVE ATTACHMENTS (Optional)

■ KDTA-20SV/100SV/200SV 200SVH



■ KDTA-1000SV/2000SV 1000SVH/2000SVH, 2000SVII



■ KDTA-3000SVH



KDTA-SVH

LARGE DIGITAL TORQUE ANALYZERS



FEATURES

- LED display eliminates reading errors.
- Processor chip assures measurement with high reliability and accuracy.
- The display unit angle can be adjusted approximately 90°.
- Can be connected to various optional equipment (printer, personal computer, external input keyboard).
- Saves time and helps speed up work.
- Equipped with a kgf-cm/N-m selector switch.

SPECIFICATIONS

- Power : AC100-240V 50/60Hz
- Accuracy : ±1% of the indicated value +1 increment, over the full range
- Display : red LED (character height : 25mm)
- Operating temperature range : 0~40°C

Model	Range(CW/CCW)		Increment	English Model	Range(CW/CCW)		Increment	Measuring mode	Unit conversion	Drive size	Weight	Included Accessory
	kgf-cm/kgf-m	N-m			lbf-in/lbf-ft	N-m						
KDTA-200SVH	20~200 kgf-cm	0.1 kgf-cm	KDTA-200SVH	17.7~177.0 lbf-in	0.1 lbf-in	RUN	Peak hold	Standard kgf-cm N-m	12	10	6.35×12 Socket 9.5×12 Socket	
	2~20 N-m	0.01 N-m		2~20 N-m	0.01 N-m							
KDTA-1000SVH	100~1000 kgf-cm	1 kgf-cm	KDTA-1000SVH	89~885 lbf-in	1 lbf-in	Peak to peak hold	English Model lb-in N-m	14	18	9.5×14 Socket 12.7×14 Socket		
	10~100 N-m	0.1 N-m		10~100 N-m	0.1 N-m							
KDTA-2000SVH	200~2000 kgf-cm	1 kgf-cm	KDTA-2000SVH	177~1770 lbf-in	1 lbf-in	Standard kgf-cm N-m	22	29	12.7×22 Socket 19.05×22 Socket			
	20~200 N-m	0.1 N-m		20~200 N-m	0.1 N-m							
KDTA-3000SVH	300~3000 kgf-cm	1 kgf-cm	KDTA-3000SVH	22.1~221.2 lbf-ft	0.1 lbf-ft	English Model lb-ft N-m	26	80	12.7×26 Socket 19.05×26 Socket			
	30~300 N-m	0.1 N-m		30~300 N-m	0.1 N-m							
KDTA-6000SVH	600~6000 kgf-cm	1 kgf-cm	KDTA-6000SVH	44.2~442.5 lbf-ft	0.1 lbf-ft	74~737 lbf-ft	1 lbf-ft	30	65	12.7×30, 19.05×30 25.4×30 Socket		
	60~600 N-m	0.1 N-m		60~600 N-m	0.1 N-m							
KDTA10000SVH	10~100 kgf-m	0.1 kgf-m	KDTA-10000SVH	100~1000 N-m	1 N-m							
	100~1000 N-m	1 N-m										

TPK-3

STANDARD PRINTER

FEATURES

- Indicates in or out of specification on the led display and print out.
- * Printer cables are options. CT-1 is for DTC series.
CSV-1 is for KDTA-SV and KDTA-SVH series.



KDTA-SVII **DIGITAL TORQUE ANALYZERS**

Highly accurate and economical torque analyzer, easy for operators to use on the job site.



FEATURES

- LED display eliminates reading errors.
- Processor chip assures measurement with high reliability and accuracy.
- Connects to an optional printer.
- Saves time and helps speed up work.
- Equipped with a kgf-cm/N-m selector switch.

SPECIFICATIONS

- Power : AC100-240V 50/60Hz
- Accuracy : $\pm 1\%$ of the indicated value + 1 increment, over the full range
- Display : red LED (character height : 25mm)
- Operating temperature range : 0~40°C

Model	Torque measuring range	Increment	English Model	Torque measuring range	Increment	Drive size	Display	Weight (kg)
KDTA-2000SV (II)	50~2000kgf-cm/5~200N-m	1kgf-cm/0.1N-m	KDTA-2000SV (II)	35~1770lb-in/5~200N-m	1lb-in/0.1N-m	14mm	Red LED	11.5

CTK-XL **CAP TESTER** **DIGITAL CAP TORQUE ANALYZERS**

Digital measurement of opening and closing torque on container caps.

FEATURES

- Optimal for measuring torque values opening or closing caps on containers for cosmetic products, medical products, foods, etc.
- Up to 100 measurements can be stored in memory.
- Upper and lower limit values can be set.
- Capable of measuring clockwise and counterclockwise values.
- The testers will handle containers in diameters ranging 10~100mm and 22~180mm.
- Accuracy : $\pm 1\%$ of indicated value + 1 increment, over the full range



* The bottle is not included.

Model	Torque range	Increment	Accuracy	Power source	Weight	Chuck diameter (mm)
CTK-30XL	3~30kgf-cm	0.02kgf-cm	$\pm 1\%$ of indicated value + 1 increment over the full range	AC100~240V (adapter DC6V)	11kg	$\phi 10\sim\phi 100$
CTK-100XL	10~100kgf-cm	0.1kgf-cm				$\phi 22\sim\phi 180$
CTK-3NXL	30~300cN-m	0.2cN-m	$\pm 1\%$ of indicated value + 1 increment over the full range	AC100~240V (adapter DC6V)	11kg	$\phi 10\sim\phi 100$
CTK-10NXL	1~10N-m	0.01N-m				$\phi 22\sim\phi 180$

KDTA-DH

DIGITAL TORQUE ANALYZERS FOR TORQUE DRIVERS



KDTA-8DH

KDTA-8DH / KDTA-80DH

FEATURES

- Designed for LTDK and STDK
- Battery powered
- Battery Charger is available for AC 100V~240V 50/60Hz
- Lightweight plastic case
- kgf·cm/N·m / lbf·in unit conversion

- MODE : RUN (constantly indicates torque value.)
PEAK HOLD
PEAK TO PEAK-HOLD
- AUTO RESET : Timer function available
- DATA OUTPUT : Digital output
- PRINTER : TPK-3 (Optional)
- Accuracy : $\pm 1\%$ of the indicated value + 1 increment, over the full range

Model	Range	Increment	Measuring mode	Battery	Size	Weight (kg)
KDTA-8DH	3~800mN·m 0.3~80cN·m 0.03~8kgf·cm 0.03~7lbf·in	0.1mN·m 0.01cN·m 0.001kgf·cm 0.001lbf·in	RUN Peak hold Peak to Peak hold	Rechargeable	230 (W) × 123 (D) × 65 (H) mm	1.8
KDTA-80DH	3~800cN·m 0.03~8N·m 0.3~80kgf·cm 0.3~70lbf·in	0.1cN·m 0.0001N·m 0.01kgf·cm 0.01lbf·in	RUN Peak hold Peak to Peak hold	Rechargeable	230 (W) × 123 (D) × 65 (H) mm	1.8

KDTA-D

DIGITAL TORQUE ANALYZERS FOR ELECTRIC DRIVERS

KDTA-10D / KDTA-100D

FEATURES

- Battery is rechargeable.
- For any brand of the Electric Driver
- Battery Charger is available for AC 100V~240V 50/60Hz

- MODE : RUN (constantly indicates torque value.)
PEAK HOLD
PEAK TO PEAK-HOLD
- AUTO RESET : Timer function available
- DATA OUTPUT : Digital output
- PRINTER : TPK-3 (Optional)
- Accuracy : $\pm 1\%$ of the indicated value + 1 increment, over the full range



Model	Range	Increment	Measuring mode	Battery	Size	Weight (kg)
KDTA-10D	1.5~100.0cN·m 0.15~10.00kgf·cm 0.13~10.00lbf·in	0.1cN·m 0.01kgf·cm 0.01lbf·in	RUN Peak hold Peak to Peak hold	Rechargeable	230 (W) × 123 (D) × 65 (H) mm	1.18
KDTA-100D	15~1000cN·m 1.5~100.0kgf·cm 1.3~100.0lbf·in	1cN·m 0.1kgf·cm 0.1lbf·in	RUN Peak hold Peak to Peak hold	Rechargeable	230 (W) × 123 (D) × 65 (H) mm	1.18

DRT

KANON TORQUE MEASUREMENT MULTI-INDICATOR

Model DRT multi-indicator handles 16 different types of work. The TEDS-based smart indicator is designed for accurate and speedy analysis of bolt-tightening.

FEATURES

- Tools are easily exchanged and calibrated. A sensor with built-in TEDS information is directly connected to a tool for automatic reading of necessary information, eliminating troublesome calibration each time a tool is exchanged (IEEE 1451.4, Class 2 mixed mode interfaced).
- Various tools can be used, including click type and non-click type torque wrench and strain gauge sensors.
- Torque values remain in waveforms, allowing the user to view torque in any desired place.
- Bolt-tightening is analyzed in a short time: Tightening, Loosening inspection, Re-tightening inspection, Torque wrench inspection, Destructive inspection



TEDS-based multi-indicating system (Examples)

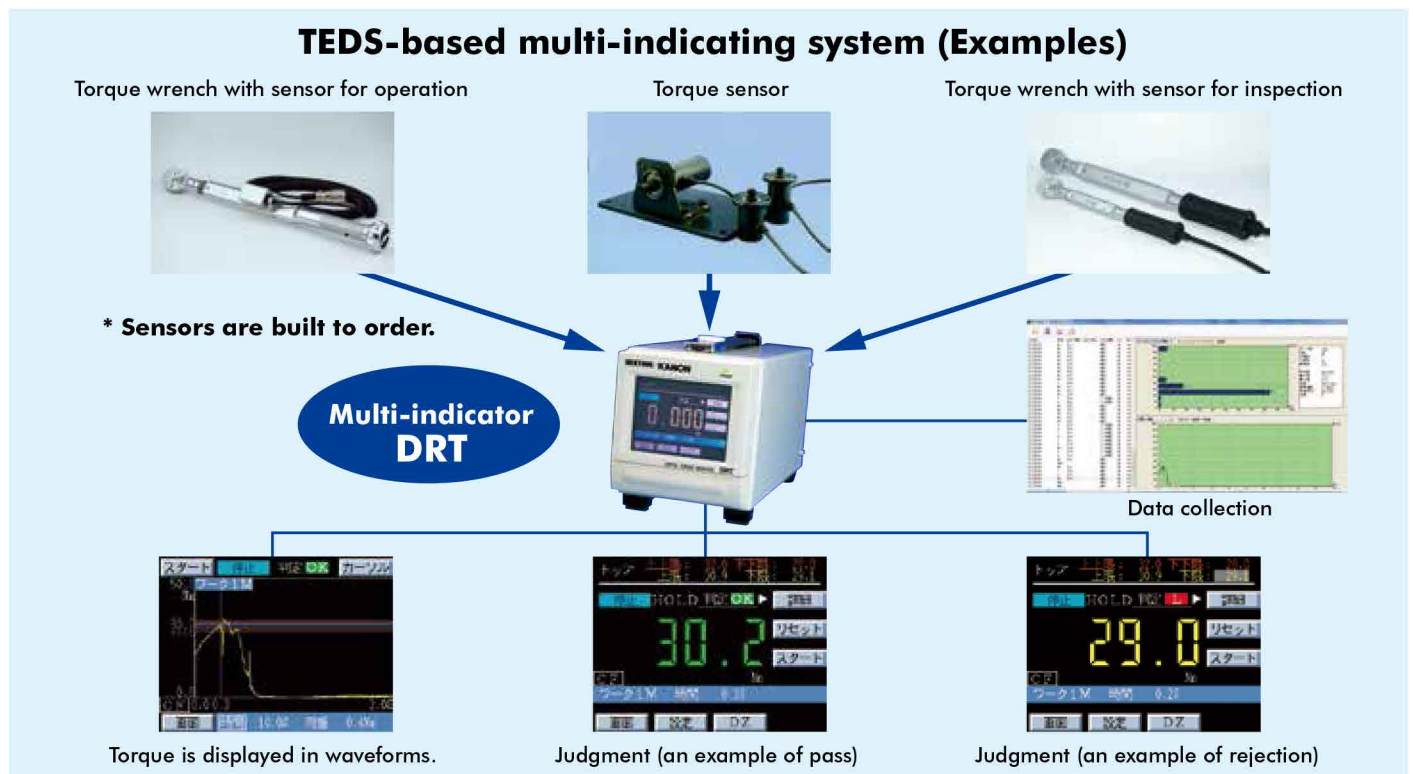

* English version is also available

<Specifications>

Model	DRT	
Display/controller	3.5 type STN color LCD (320 x 240 dots)	
	Controller	Touch panel
	Display range	0 to ±9999
	Decimal point position	Arbitrarily selected
	Display change frequency	3 times/s
	Time axis	0.1 to 99.9s
Operation screen	Digital load display screen, waveform display screen, setting screen, strain display.	
Setting	Comparative judgment values	
Function	Hold function	Load value: upper limit, lower limit, upper-upper limit, and lower-lower limit
	Clock function	Inflection point, sample, peak, maximal and minimal hold
Data output	Data is controlled and saved according to real-time clock.	
Power supply	RS-232C, CF card	
Operating temperature range	AC 100 to 240V	
Weight	0 to +40°C	
Dimensions	2.8kg	
Applicable standards	EMC	107 (W) x 140 (H) x 257 (D) mm
	Safety standards	VCCI 1 (Class A), EN55011 (Class A), EN61326-4-2, 3, 4, 5, 6, 8, 11, EN61000-3-2, 3
		EN61010-1

MLQK MARKING TORQUE WRENCHES

No tightening negligence with marking check.

FEATURES

- To click torque wrench and the bolt is painted.
No marking without click.
- 6000 times can be marked with 14 to 24mm socket.
- 1500 times can be marked with 8 to 13mm socket.
- Easy maintenance.
- Accuracy : ±3%
- Please select the size of socket when you order MLQK.
Socket is modified for MLQK



MLQK

* Ink is not included

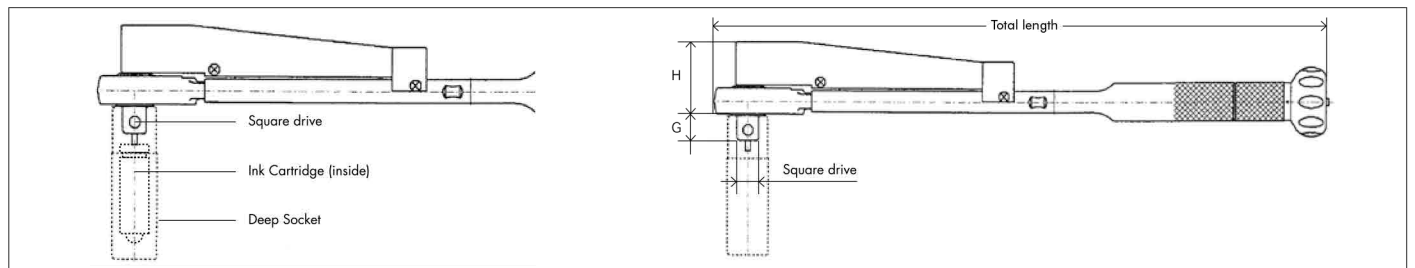

Model (kgf·cm)	Range kgf·cm	Increment	Old Model (N·m)	New Model (N·m)	Range N·m	Increment	Square drive mm	Total length mm	Dimensions (mm)		Weight kg	Optional socket mm
									H	G		
250MLQK	70~250	0.2	N250MLQK	N25MLQK	7~25	0.2	9.53	232	54	11	0.37	8~24
500MLQK	100~500	0.5	N500MLQK	N50MLQK	10~50	0.5	(3/8")	254	54	11	0.55	8~24
1000MLQK	200~1,000	1	N1000MLQK	N100MLQK	20~100	1	12.7	352	57	14	0.89	13~24
1400MLQK	400~1,400	1	N1400MLQK	N140MLQK	40~140	1	(1/2")	392	57	14	0.95	13~24

MLQK-E HEXAGON MARKING TORQUE WRENCHES

No tightening negligence with marking check.

FEATURES

- A mark is automatically painted when the specified torque is reached; an electric signal is triggered to pop up the paint marker at the tip of the wrench to mark.
- Marking position is finely adjustable front to back and side to side. Marks can also be printed on the side of a socket bolt, or the head or periphery of a buried bolt.



MLQK-E

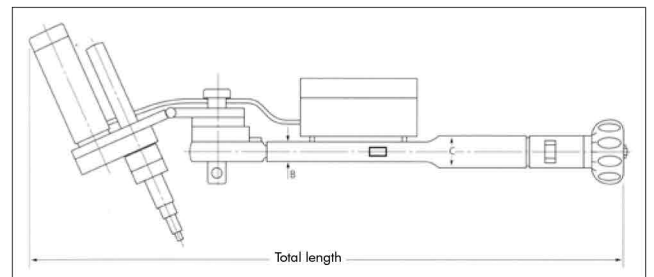

BATTERY CHARGER SPECIFICATIONS

- Input : 100-240VAC, 50/60Hz
- Cell : 2S and 3S
- Output current : 3 × 850mA



Model (kgf·cm)	Range kgf·cm	Increment	Old Model (N·m)	New Model (N·m)	Range N·m	Increment	Square drive mm	Total length mm	Dimensions (mm)		Weight kg
									B	C	
60MLQK-E	20~60	1	N60MLQK-E	N6MLQK-E	2~6	0.1	9.53 (3/8")	327	10	15	0.7
120MLQK-E	40~120	2	N120MLQK-E	N12MLQK-E	4~12	0.2					
250MLQK-E	70~250	2	N250MLQK-E	N25MLQK-E	7~25	0.2		349	20	22	1
500MLQK-E	100~500	5	N500MLQK-E	N50MLQK-E	10~50	0.5					
1000MLQK-E	200~1000	10	N1000MLQK-E	N100MLQK-E	20~100	1	12.7	452	12	22	1.3
1400MLQK-E	400~1400	10	N1400MLQK-E	N140MLQK-E	40~140	1	(1/2")	492			

* is the new model that is applied from 1st January, 2016.

TCSK-99MA

MULTI-FUNCTION TORQUE TASK MANAGER / ANALYZER

The multi-controller, the "Careless Mistake Detector" has a 100-240V multi-input type power system.

SWPM Series

TORQUE TOOLS FOR TCSK

SWP tools connect with TCSK-99MA and prevent missing tightening joints.



This is an extremely useful multi-function controller that can serve many purposes, such as detecting loose joints, eliminating faulty fastener tightening, and task time management through connection with a KANON torque wrench, or torque driver.

FEATURES

- TCSK-99MA connects to KANON SWPM series torque tools.
- The red LED indicators are large and easy-to-read, allowing the operator to check the settings and progress of fastener tightening work at a glance. With visible and audible signals, the TCSK-99MA prevents you from leaving joints loose during fastener tightening work.
- Compared with conventional products, TCSK-99MA offers many different functions at a lower price.
- TCSK-99MA can help manage work processes via external output signals.

* This item does not have the CE mark.

Model	TCSK-99MA
Count	1 to 99
Timer setting	Digital input (set time for each function)
Judgement	OK (sounds and LED lights up in green) NG (sounds and LED lights up in red)
External input	Start, stop, reset, direction of rotation, work, lock
External output	Count OK, work NG/OK, overtime NG, in-time NG
Power supply	Input (primary side), switching power type multi-input of 100 to 240 VAC Output(secondary side) 24VDC, 2A 50W
Power consumption	10W
Outside dimensions	209mm (W)×77mm(H)×180mm(D)
Weight	approximately 1.7kg

FEATURES

- When the tool clicks, indicating the joint is tightened to the specified torque, a signal is sent to the TCSK-99MA.

SWPM TYPES ● Type and torque range

Model	Available Models
SPK-SWPM	190SPK~4200SPK N190SPK~N4200SPK
RSPK-SWPM	190RSPK~4200RSPK N190RSPK~N4200RSPK
QSPK-SWPM	PI60QSPK~PI2800QSPK / PF4200QSPK 60QSPK~4200QSPK N60QSPK~N4200QSPK
SPCK-SWPM	60SPCK~4400SPCK N60SPCK~N4400SPCK

- Accuracy : $\pm 3\%$ of pre-set value

QLK-SWPM	PI60QLK~PI2000QLK 60QLK~2800QLK N60QLK~N2800QLK
LCK-SWPM	60LCK~2800LCK N60LCK~N2800LCK

- Accuracy : $\pm 3\%$ of indicated value over the full range

LTDK-SWP	OI200LTDK / PI30LTDK~PI50LTDK 12LTDK~100LTDK N12LTDK~N100LTDK
----------	---

- Accuracy : $\pm 3\%$ of indicated value over the full range, clockwise

* Torque wrench setting of N450QLK-SWPM less than 10N·m and 450QLK-SWPM less than 100kgf·cm does not go signal properly.

TK TENSION GAUGES

Demonstrating KANON's measuring versatility.
Great performance whether measuring vertically or horizontally.

FEATURES

- Measures pushing, pulling force and spring tension.
Our tension gauges are designed to indicate precise increments of force.
- Use the gauges for taking horizontal measurements. Just add the correcting value to the indicated value (see the table below). A peak indicator is available for TK500 to TK300 and TK500cN to TK3000cN.
- Accuracy : ± 1 increment

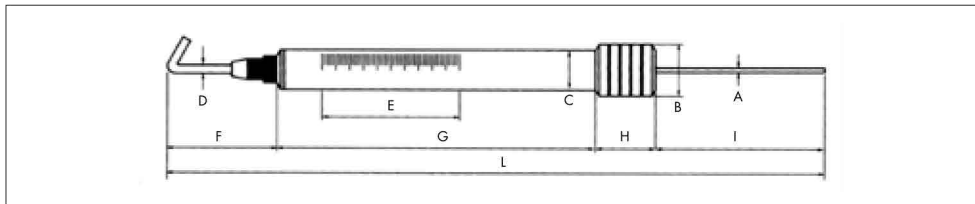

Model (g)	Range (g)	Incr. (g)	A mm	B mm	C mm	D mm	E mm	F mm	G mm	H mm	I mm	L mm	Weight (g)	Correcting value for horizontal measurements (g)
TK10	0 ~ 10	0.5	1.5	16	13	1.5	40	19	98	15	48	180	30	3
TK30	0 ~ 30	1	1.5	16	13	1.5	60	19	113	15	66	213	30	3
TK50	0 ~ 50	1	1.5	16	13	1.5	60	19	113	15	66	213	30	3
TK110	0 ~ 110	2	2	16	13	2	60	27.5	113	15	65.5	221	35	10
TK200	0 ~ 200	5	2	16	13	2	60	27.5	113	15	65.5	221	35	10
TK300	0 ~ 300	5	2	16	13	2	60	27.5	113	15	65.5	221	35	10
TK500	0 ~ 500	10	3	20	16	2.6	56	43	131	25	69	268	78	30
TK600	0 ~ 600	20	3	20	16	2.6	56	43	131	25	69	268	78	30
TK1000	0 ~ 1000	25	3	20	16	2.6	56	43	131	25	69	268	78	30
TK1500	0 ~ 1500	50	3	20	16	2.6	56	43	131	25	69	268	78	30
TK2000	0 ~ 2000	50	3	20	16	2.6	56	43	131	25	69	268	78	30
TK2500	0 ~ 2500	50	3	20	16	2.6	62	43	143	25	74	285	85	50
TK3000	0 ~ 3000	50	3	20	16	2.6	62	43	143	25	74	285	85	50
TK4000	0 ~ 4000	50	4	25	22	3.5	68	43	178	35	82	338	200	100
TK5000	0 ~ 5000	100	4	25	22	3.5	68	43	178	35	82	338	200	100
TK7000	0 ~ 7000	200	4	25	22	3.5	68	43	178	35	82	338	205	100
TK10000	0 ~ 10000	200	4	25	22	3.5	68	43	178	35	82	338	205	100
TK15000	0 ~ 15000	200	8	35	32	7	95	83	230	35	145	493	600	250
TK20000	0 ~ 20000	200	8	35	32	7	118	83	280	35	140	538	680	250
TK30000	0 ~ 30000	500	8	40	38	7	130	83	305	35	172	595	830	350

Model (cN)	Range (cN)	Incr. (cN)	A mm	B mm	C mm	D mm	E mm	F mm	G mm	H mm	I mm	L mm	Weight (g)	Correcting value for horizontal measurements (cN)
TK10cN	0 ~ 10	0.5	1.5	16	13	1.5	40	19	98	15	48	180	30	3
TK30cN	0 ~ 30	1	1.5	16	13	1.5	60	19	113	15	66	213	30	3
TK50cN	0 ~ 50	1	1.5	16	13	1.5	60	19	113	15	66	213	30	3
TK110cN	0 ~ 110	2	2	16	13	2	60	27.5	113	15	65.5	221	35	10
TK200cN	0 ~ 200	5	2	16	13	2	60	27.5	113	15	65.5	221	35	10
TK300cN	0 ~ 300	5	2	16	13	2	60	27.5	113	15	65.5	221	35	10
TK500cN	0 ~ 500	10	3	20	16	2.6	56	43	131	25	69	268	78	30
TK600cN	0 ~ 600	20	3	20	16	2.6	56	43	131	25	69	268	78	30
TK1000cN	0 ~ 1000	25	3	20	16	2.6	56	43	131	25	69	268	78	30
TK1500cN	0 ~ 1500	50	3	20	16	2.6	56	43	131	25	69	268	78	30
TK2000cN	0 ~ 2000	50	3	20	16	2.6	56	43	131	25	69	268	78	30
TK2500cN	0 ~ 2500	50	3	20	16	2.6	62	43	143	25	74	285	85	50
TK3000cN	0 ~ 3000	50	3	20	16	2.6	62	43	143	25	74	285	85	50
TK4000cN	0 ~ 4000	50	4	25	22	3.5	68	43	178	35	82	338	200	100
TK5000cN	0 ~ 5000	100	4	25	22	3.5	68	43	178	35	82	338	200	100
TK7000cN	0 ~ 7000	200	4	25	22	3.5	68	43	178	35	82	338	205	100
TK10000cN	0 ~ 10000	200	4	25	22	3.5	68	43	178	35	82	338	205	100
TK15000cN	0 ~ 15000	200	8	35	32	7	95	83	230	35	145	493	600	250
TK20000cN	0 ~ 20000	200	8	35	32	7	118	83	280	35	140	538	680	250
TK30000cN	0 ~ 30000	500	8	40	38	7	130	83	305	35	172	595	830	350



TK

- If you take a measurement horizontally, add the correcting value to the indicated measurement value per the table.

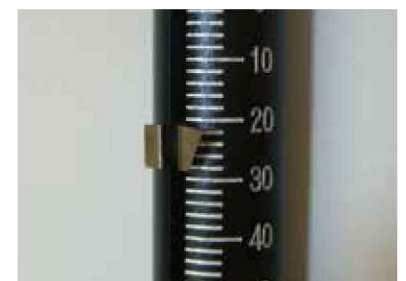

* Peak indicator is optional

- If you would like your TK gauge with a peak indicator, please specify "TK-G" on your purchase order.
ex. TK500cN-G

DTC-EXL DATA PRINT-OUT DIGITAL TORQUE WRENCHES

Newly designed, features a multi-function digital read-out.



FEATURES

- Accuracy : $\pm 1\%$ of indicated value +1 increment, over the full range
- Display : torque reading 4-digit LCD display
- Measurement modes : ①Peak hold ②Peak to peak-hold ③Run
- Direction of measurement : Automatic CW/CCW changeover, provided with CW/CCW status display
- Power supply : two rechargeable "AA" 1.2V batteries and a 100-240V battery charger
- Battery life : Approximately 20 hours with fully charged batteries (continuous operation)
- Power off : Auto power-off, approximately 3 minutes 40 seconds
- Tolerance setting : Automatic judgement capability per the Min/Max settings
- Data memory : 100 pieces of data
- Output : Printer output (exclusively to a TPK-3), analog output << 0 to 1.024 (mid point) to 2.048 V >>

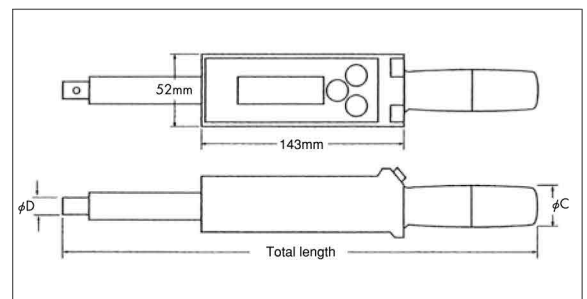

Model	Range (CW/CCW)	Increment	Total length (mm)	φ D (mm)	φ C (mm)	Weight (kg)	Accessory
DTC-100EXL	10~100 kgf-cm	0.1 kgf-cm	300	10	26	0.7	120 QCK
DTC-500EXL	50~500 kgf-cm	0.5 kgf-cm	324	12	26	0.7	450 QCK
DTC-1000EXL	100~1000 kgf-cm	1 kgf-cm	365	15	32	0.8	900 QCK
DTC-2000EXL	200~2000 kgf-cm	1 kgf-cm	380	18	32	0.9	1800 QCK
DTC-3000EXL	3~30 kgf-m	0.02 kgf-m	535	22	32	1.5	2800 QCK-A
DTC-5000EXL	5~50 kgf-m	0.05 kgf-m	1,063	30	34	3.9	7000 QCK
DTC-10000EXL	10~100 kgf-m	0.1 kgf-m	1,417	34	34	7.3	10000 QCK
DTC-N10EXL	1~10 N-m	0.01 N-m	300	10	26	0.7	120 QCK
DTC-N50EXL	5~50 N-m	0.05 N-m	324	12	26	0.7	450 QCK
DTC-N100EXL	10~100 N-m	0.1 N-m	365	15	32	0.8	900 QCK
DTC-N200EXL	20~200 N-m	0.1 N-m	380	18	32	0.9	1800 QCK
DTC-N300EXL	30~300 N-m	0.2 N-m	535	22	32	1.5	2800 QCK-A
DTC-N500EXL	50~500 N-m	0.5 N-m	1,063	30	34	3.9	7000 QCK
DTC-N1000EXL	100~1000 N-m	1 N-m	1,417	34	34	7.3	10000 QCK
DTC-PI80EXL	8~80 lbf-in	0.01 lbf-in	300	10	26	0.7	120 QCK
DTC-PI400EXL	40~400 lbf-in	0.1 lbf-in	324	12	26	0.7	450 QCK
DTC-PI800EXL	80~800 lbf-in	0.1 lbf-in	365	15	32	0.8	900 QCK
DTC-PF100EXL	10~100 lbf-ft	0.1 lbf-ft	380	18	32	0.9	1800 QCK
DTC-PF200EXL	20~200 lbf-ft	0.1 lbf-ft	535	22	32	1.5	2800 QCK-A
DTC-PF400EXL	40~400 lbf-ft	0.2 lbf-ft	1,063	30	34	3.9	7000 QCK
DTC-PF800EXL	80~800 lbf-ft	1 lbf-ft	1,417	34	34	7.3	10000 QCK

DTDK-EXL DIGITAL TORQUE DRIVER WITH CONNECTED DISPLAY

The display is separate from the driver. Complete tightening control for small screws.

FEATURES

- Accuracy : $\pm 1\%$ of indicated value +1 increment, over the full range
- Display : torque reading 4-digit LCD display
- Measurement modes : ①Peak hold ②Peak to peak-hold ③Run
- Direction of measurement : Automatic CW/CCW changeover, provided with CW/CCW status display
- Power supply : two rechargeable "AA" 1.2V batteries and a 100-240V battery charger
- Battery life : Approximately 20 hours with fully charged batteries (continuous operation)
- Power off : Auto Power-off, approximately 3 minutes 40 seconds
- Tolerance setting : Automatic judgement capability per the Min/Max settings
- Data memory : 100 pieces of data
- Output : Printer output (exclusively to a TPK-3), analog output << 0 to 1.024 (mid point) to 2.048 V >>

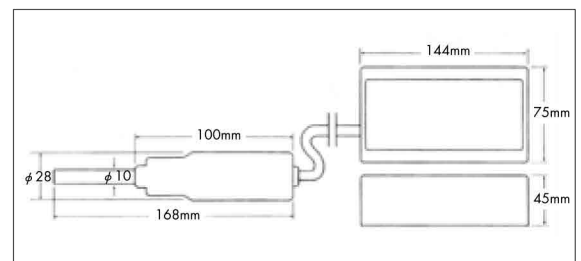

Old Model	New Model	Range (CW/CCW)	Increment	Weight (kg)	Included Accessory	
					Standard bits	Phillips SB type
DTDK-20EXL		2~20 kgf·cm	0.01 kgf·cm	1	No.0, No.1	
DTDK-50EXL		5~50 kgf·cm	0.05 kgf·cm	1	No.1, No.2	
DTDK-N2EXL	DTDK-CN200EXL	20~200 cN·m	0.1 cN·m	1	No.0, No.1	
DTDK-N5EXL	DTDK-CN500EXL	50~500 cN·m	0.5 cN·m	1	No.1, No.2	
DTDK-PI40EXL		4~40 lbf·in	0.01 lbf·in	1	No.1, No.2	

DTC-N5EXL DIGITAL TORQUE WRENCH WITH CONNECTED DISPLAY

The display is separate from the wrench. The slender wrench body facilitates measuring lower torques.

FEATURES

- Accuracy : $\pm 1\%$ of indicated value +1 increment, over the full range
- Display : torque reading 4-digit LCD display
- Measurement modes : ①Peak hold ②Peak to peak-hold ③Run
- Direction of measurement : Automatic CW/CCW changeover, provided with CW/CCW status display
- Power supply : two rechargeable "AA" 1.2V batteries and a 100-240V battery charger
- Battery life : Approximately 20 hours with fully charged batteries (continuous operation)
- Power off : Auto Power-off, approximately 3 minutes 40 seconds
- Tolerance setting : Automatic judgement capability per the Min/Max settings
- Data memory : 100 pieces of data
- Output : Printer output (exclusively to a TPK-3), analog output << 0 to 1.024 (mid point) to 2.048 V >>

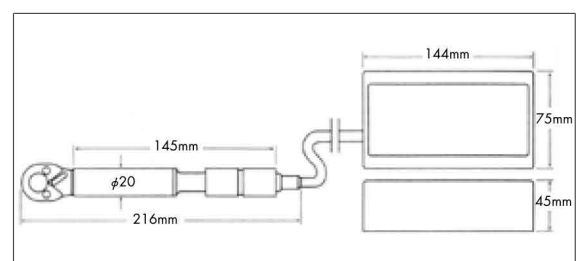

Old Model	New Model	Range (CW/CCW)	Increment	Weight (kg)	Accessory
DTC-50EXL		5~50 kgf·cm	0.05 kgf·cm	0.9	120QCK
DTC-N5EXL	DTC-CN500EXL	50~500 cN·m	0.5 cN·m	0.9	120QCK
DTC-PI40EXL		4~40 lbf·in	0.01 lbf·in	0.9	120QCK

* is the new model that is applied from 1st January, 2016.

BITS

BITS FOR TORQUE DRIVERS

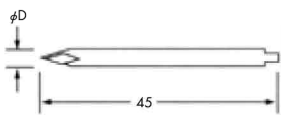
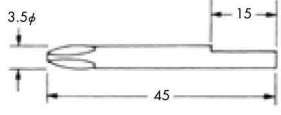
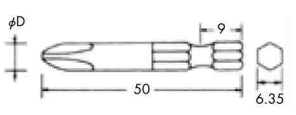
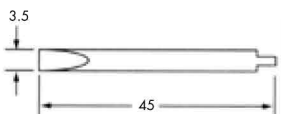
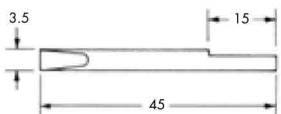
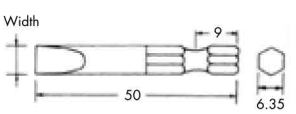
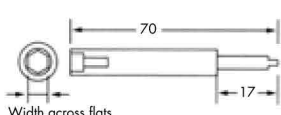
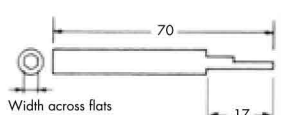
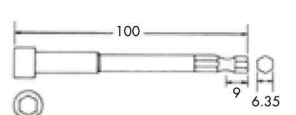
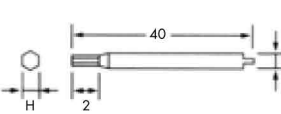
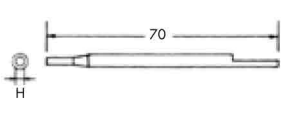
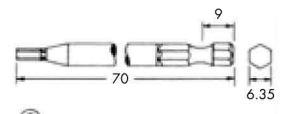
Type	CB type (KANON bits)	OB type (KANON bits)	SB type (Standard bits)																																								
Applicable driver	N1.5, 3 LTKD (N)1.5, 3STDK OI 22, 44, STDK	1.5, 3 LTKD (N) 1, 2, 5 DPSK	(N)1.5, 3 LTKD-H, (N)6, 12, 20, 30, 50, 100LTKD OI 200LTKD, PI 30, 50, LTKD (N)6, 12, 20, 30, 50, 100STDK OI 80, 200STDK, PI 20, 30, 50, 100STDK (N)10, 20, 50DPSK, (N)10, 20, 50DPSKII DTDK-20, 50EXL, DTDK-N2, NS EXL																																								
Phillips	 <p>Unit : mm</p> <table border="1"> <thead> <tr> <th>ϕD</th> <th>Bit sizes</th> </tr> </thead> <tbody> <tr> <td rowspan="4">3.5ϕ</td> <td>No.00</td> </tr> <tr> <td>No.0</td> </tr> <tr> <td>No.1</td> </tr> <tr> <td>No.2</td> </tr> </tbody> </table>	ϕD	Bit sizes	3.5 ϕ	No.00	No.0	No.1	No.2	 <p>Unit : mm</p> <table border="1"> <thead> <tr> <th>ϕD</th> <th>Bit sizes</th> </tr> </thead> <tbody> <tr> <td rowspan="4">3.5ϕ</td> <td>No.00</td> </tr> <tr> <td>No.0</td> </tr> <tr> <td>No.1</td> </tr> <tr> <td>No.2</td> </tr> </tbody> </table>	ϕD	Bit sizes	3.5 ϕ	No.00	No.0	No.1	No.2	 <p>Unit : mm</p> <table border="1"> <thead> <tr> <th>ϕD</th> <th>Bit sizes</th> </tr> </thead> <tbody> <tr> <td rowspan="2">4ϕ</td> <td>No.0</td> </tr> <tr> <td>No.1</td> </tr> <tr> <td rowspan="2">7ϕ</td> <td>No.2</td> </tr> <tr> <td>No.3</td> </tr> </tbody> </table>	ϕD	Bit sizes	4 ϕ	No.0	No.1	7 ϕ	No.2	No.3																		
ϕD	Bit sizes																																										
3.5 ϕ	No.00																																										
	No.0																																										
	No.1																																										
	No.2																																										
ϕD	Bit sizes																																										
3.5 ϕ	No.00																																										
	No.0																																										
	No.1																																										
	No.2																																										
ϕD	Bit sizes																																										
4 ϕ	No.0																																										
	No.1																																										
7 ϕ	No.2																																										
	No.3																																										
Slot Drive	 <p>Unit : mm</p> <table border="1"> <thead> <tr> <th>\ominus Blade thickness</th> <th>Width</th> </tr> </thead> <tbody> <tr> <td>0.4mm</td> <td>3.5mm</td> </tr> </tbody> </table>	\ominus Blade thickness	Width	0.4mm	3.5mm	 <p>Unit : mm</p> <table border="1"> <thead> <tr> <th>\ominus Blade thickness</th> <th>Width</th> </tr> </thead> <tbody> <tr> <td>0.4mm</td> <td>3.5mm</td> </tr> </tbody> </table>	\ominus Blade thickness	Width	0.4mm	3.5mm	 <p>Unit : mm</p> <table border="1"> <thead> <tr> <th>\ominus Blade thickness</th> <th>Width</th> </tr> </thead> <tbody> <tr> <td>0.4mm</td> <td>4.0mm</td> </tr> <tr> <td>1.0mm</td> <td>7.0mm</td> </tr> </tbody> </table>	\ominus Blade thickness	Width	0.4mm	4.0mm	1.0mm	7.0mm																										
\ominus Blade thickness	Width																																										
0.4mm	3.5mm																																										
\ominus Blade thickness	Width																																										
0.4mm	3.5mm																																										
\ominus Blade thickness	Width																																										
0.4mm	4.0mm																																										
1.0mm	7.0mm																																										
BOX BITS (Female Hex)	 <p>Unit : mm</p> <table border="1"> <thead> <tr> <th colspan="5">Width across flats</th> </tr> </thead> <tbody> <tr> <td>3</td> <td>4</td> <td>5</td> <td>5.5</td> <td>6</td> </tr> </tbody> </table>	Width across flats					3	4	5	5.5	6	 <p>Unit : mm</p> <table border="1"> <thead> <tr> <th colspan="5">Width across flats</th> </tr> </thead> <tbody> <tr> <td>3</td> <td>4</td> <td>5</td> <td>5.5</td> <td>6</td> </tr> </tbody> </table>	Width across flats					3	4	5	5.5	6	 <p>Unit : mm</p> <table border="1"> <thead> <tr> <th colspan="5">Width across flats</th> </tr> </thead> <tbody> <tr> <td>4</td> <td>5</td> <td>5.5</td> <td>6</td> <td>7</td> </tr> <tr> <td>8</td> <td>9</td> <td>10</td> <td>11</td> <td>12</td> </tr> <tr> <td>13</td> <td>14</td> <td>17</td> <td></td> <td></td> </tr> </tbody> </table>	Width across flats					4	5	5.5	6	7	8	9	10	11	12	13	14	17		
Width across flats																																											
3	4	5	5.5	6																																							
Width across flats																																											
3	4	5	5.5	6																																							
Width across flats																																											
4	5	5.5	6	7																																							
8	9	10	11	12																																							
13	14	17																																									
HEX BITS (Male Hex)	 <p>Unit : mm</p> <table border="1"> <thead> <tr> <th colspan="5">Edge size (H) mm</th> </tr> </thead> <tbody> <tr> <td>1.27</td> <td>1.5</td> <td>2</td> <td>2.5</td> <td>3</td> </tr> </tbody> </table>	Edge size (H) mm					1.27	1.5	2	2.5	3	 <p>Unit : mm</p> <table border="1"> <thead> <tr> <th colspan="5">Edge size (H) mm</th> </tr> </thead> <tbody> <tr> <td>1.27</td> <td>1.5</td> <td>2</td> <td>2.5</td> <td>3</td> </tr> </tbody> </table>	Edge size (H) mm					1.27	1.5	2	2.5	3	 <p>Unit : mm</p> <table border="1"> <thead> <tr> <th colspan="5">Edge size (H) mm</th> </tr> </thead> <tbody> <tr> <td>1.27</td> <td>1.5</td> <td>2</td> <td>2.5</td> <td>3</td> </tr> <tr> <td>4</td> <td>5</td> <td>6</td> <td>8</td> <td></td> </tr> </tbody> </table>	Edge size (H) mm					1.27	1.5	2	2.5	3	4	5	6	8						
Edge size (H) mm																																											
1.27	1.5	2	2.5	3																																							
Edge size (H) mm																																											
1.27	1.5	2	2.5	3																																							
Edge size (H) mm																																											
1.27	1.5	2	2.5	3																																							
4	5	6	8																																								

PARTS FOR QLK, QSPK AND QCK

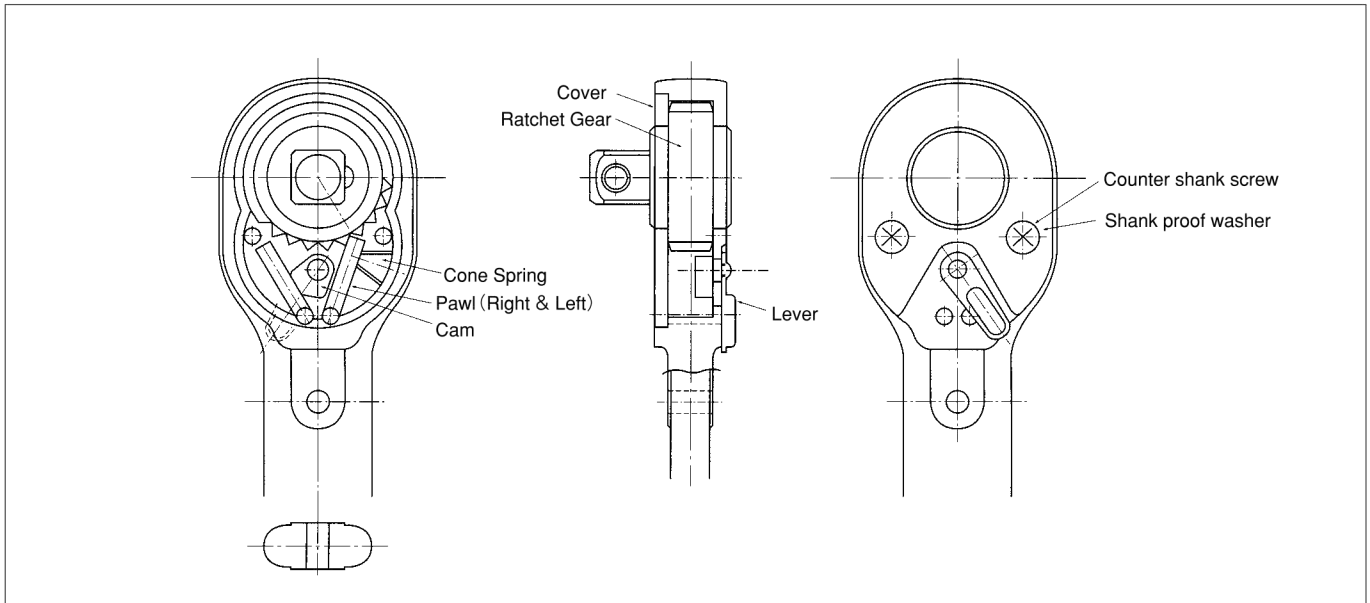

■ Torque unit and conversion table

	Metric unit	SI unit	Imperial unit
Torque unit	kgf·cm kgf·m gf·cm	N·m cN·m	lbf·in lbf·ft OZf·in
Conversion in unit	1 kgf·m=100 kgf·cm 1 kgf·cm=1000 gf·cm 1 kgf·cm=10 kgf·mm	1 N·m=100 cN·m	1 lbf·ft=12 lbf·in 1 lbf·in=16 OZf·in
Conversion between units	1 kgf·cm=0.098065 N·m 1 kgf·cm=0.867962 lbf·in 1 kgf·cm=0.072330 lbf·ft	1 N·m=10.1972 kgf·cm 1 N·m=8.85 lbf·in 1 N·m=0.737562 lbf·ft	1 lbf·in=1.153 kgf·cm 1 lbf·in=0.112985 N·m 1 lbf·ft=13.825 kgf·cm 1 lbf·ft=1.355 N·m
Force unit	1 kgf =9.807 N 1 kgf =2.205 lbf	1 N=0.101972 kgf 1 N=0.224809 lbf	1 lbf=0.453592 kgf 1 lbf=4.448 N (1 lbf=16 OZf)
Length unit	1 cm=0.393701 in	1 m=3.281 ft	1 in=2.54 cm 1 ft=0.305 m (1 ft=12 in)



<http://www.bestool-kanon.co.jp>

Improvement specifications subject to change without notice.

Distributed by:

Produced by :

NAKAMURA MFG.CO.,LTD.

4-4, Ohi 4-Chome, Shinagawa-ku, Tokyo 140-0014, Japan

2015.08-7000